

DDCouplings[®]
Dry Disconnect Couplings



Product Information

KilltheSpill

KilltheSpill

About Mann Tek

Mann Teknik AB is a Swedish company located in Mariestad, Sweden.

Mann Tek produces and markets products for a safe and environmentally friendly handling of chemicals, petroleum based products, gases and other hazardous or sensitive media.

Main products are Dry Disconnect Couplings (DDCouplings®), for spill free liquid handling.

Since its foundation in 1995, Mann Tek has continuously grown and built up extensive competence in the construction, production and distribution of DDCouplings®.

Due to their robust construction and reliable quality, these couplings have gained a solid market reputation.

Mann Tek is certified to ISO 9001:2008. The products are CE-labeled, and a major part of the product range is certified to European Pressure Equipment Directive PED and ATEX.

Products are produced in accordance with several recognized standards, e.g. to NATO STANAG 3756.

Contact Mann Tek







Phone: +46 501 39 32 00

Email: sales@mann-tek.com

Web site: www.mann-tek.com

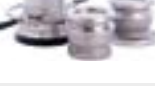

Table of Content

1" (Ø 56 mm) Tank Unit (Adapter) and Hose Unit (Coupler)		4-8
2" (Ø 70 mm) Tank Unit (Adapter) and Hose Unit (Coupler)		9-13
2½" (Ø 105 mm) Tank Unit (Adapter) and Hose Unit (Coupler)		14-17
3" (Ø 119 mm) Tank Unit (Adapter) and Hose Unit (Coupler)		18-21
4" (Ø 164 mm) Tank Unit (Adapter) and Hose Unit (Coupler)		22-24
6" (Ø 238 mm) Tank Unit (Adapter) and Hose Unit (Coupler)		25-26
8" (Ø 272 mm) Tank Unit (Adapter) and Hose Unit (Coupler)		27-28
Dust Cap for Tank Unit (Adapter)		29
Pressure Cap for Tank Unit (Adapter) - Overview and "How it Works"		30
Sealing Cap for Tank Unit (Adapter)		31
Dust Plug for Hose Unit (Coupler)		31
Parking Adapter		32
Selectivity Overview		32
Selectivity 1" - 6"		33-36
Order Number Breakdown		37-38
DDCouplings - Options and Special Versions		39-43
Flange Facing Types to EN 1092		44
Flange Measurements		45-46
Thread Seals (Flat Seals)		47
O-Ring Materials		48
About NPT and BSP Threads		49
Operating Advice for Mann Tek Couplings		50
Service Instructions, Instructions for Correct Installation and Maintenance		51-52
Flow Diagram / Pressure Drop		53
Repair Service: Certificate of Decontamination		54
Company and Product Information, Approvals and Your Distributor		56

No part of this brochure may be produced in any form or by means without permission in writing from the publisher.

Note: Mann Tek reserves the right to make design modifications without previous written notice.

1" (Ø 56 mm) Technical Information

Tank Unit (Adapter) and Hose Unit (Coupler)



Material	Maximum Working Pressure	Test Pressure	Minimum Burst Pressure
Aluminium	16 bar / 232 psi	24 bar / 348 psi	80 bar / 1160 psi
Brass/Gunmetal	16 bar / 232 psi	24 bar / 348 psi	80 bar / 1160 psi
Stainless Steel	25 bar / 363 psi	37,5 bar / 544 psi	125 bar / 1813 psi
Titan	25 bar / 363 psi	37,5 bar / 544 psi	125 bar / 1813 psi
Hastelloy	25 bar / 363 psi	37,5 bar / 544 psi	125 bar / 1813 psi
PEEK	6 bar / 87 psi	9 bar / 131 psi	30 bar / 435 psi

Connections

¾", 1" and 1¼" in BSP, NPT or metrical thread, or flanged inlet.

Applications

For industrial process plant, road and rail tankers, IBC containers, pharmaceutical and petrochemical industries, diesel locomotive refuelling etc.

Recommended for all types of mini bulk liquid product transfer, including container and drum filling, or on any application where spillage needs to be minimized.

Media

Petroleum products: gasoline, diesel, oil etc.

Chemical products: e.g. ethylene oxide, propylene oxide, acrylonitrile, butadiene, ammonia, vinyl chloride, toluene, xylene, sulphuric acid, phenol etc.

Gas: vapor recovery/balance systems for various media.

Material of Body

Aluminium, brass, stainless steel, Hastelloy and PEEK. Others on request.

Seals

Standard seals in FPM (Viton®) - alternatively EPDM, FKM (Chemraz®, Kalrez®), NBR/HBNR. Other materials on request.

High Flow Rates / Low Pressure Drop

Allows maximum product transfer with minimal losses

Recommended Maximum Flow Rates

200 litres/minute (fuel)

Selectivity

- avoid mixing products

To avoid product contamination caused by connecting a hose unit to the wrong tank unit, selective versions of the hose and tank units are available. Each unit has a number of selective positions, designated by a coded part number according to the coupling size – specify when placing order. See page 32 ff.

Interchangeability

Compatible with couplings of other manufacturers.

Hose Unit with Integrated Swivel

All hose units are supplied with an integrated swivel.

1" (Ø 56 mm) Tank Unit (Adapter) – Female Thread

Connection ¹⁾ Inch/DN	Body Material ²⁾	Seal		Weight ≈		Mann Tek Code No.				
		O-Ring ³⁾	Flat Seal	kg	lbs					
F 1/2" BSP	Al		PUR (Polyurethane)	0,3	0.7	T1133A1101B				
F 3/4" BSP						T101A1101B				
F 1" BSP						T103A1101B				
F 1 1/4" BSP						T105A1101B				
F M 54 x 1,5						T1138A1101B				
F 1/2" NPT			—			T1132A1101				
F 3/4" NPT						T102A1101				
F 1" NPT						T104A1101				
F 1 1/4" NPT						T106A1101				
F 1/2" BSP						Br		PUR (Polyurethane)	0,7	1.5
F 3/4" BSP	T101A2201B									
F 1" BSP	T103A2201B									
F 1 1/4" BSP	T105A2201B									
F M 54 x 1,5	T1138A2201B									
F 1/2" NPT	—	T1132A2201								
F 3/4" NPT		T102A2201								
F 1" NPT		T104A2201								
F 1 1/4" NPT		T106A2201								
F 1/2" BSP		SS	Standard: FPM/FKM (Viton®)	PTFE (Teflon®)	0,7			1.5		
F 3/4" BSP	T101A4401A									
F 1" BSP	T103A4401A									
F 1 1/4" BSP	T105A4401A									
F M 54 x 1,5	T1138A4401A									
F 1/2" NPT	Other on request.			—		T1132A4401				
F 3/4" NPT						T102A4401				
F 1" NPT						T104A4401				
F 1 1/4" NPT						T106A4401				
F 3/4" BSP						Titan			PTFE (Teflon®)	0,4
F 1" BSP	T103A6601A									
F 1 1/4" BSP	T105A6601A									
F 3/4" NPT	T102A6601									
F 1" NPT	T104A6601									
F 1 1/4" NPT	T106A6601									
F 3/4" BSP	Hastelloy		PTFE (Teflon®)	0,8	1.8			T101A7701A		
F 1" BSP								T103A7701A		
F 1 1/4" BSP								T105A7701A		
F 3/4" NPT								T102A7701		
F 1" NPT						T104A7701				
F 1 1/4" NPT			T106A7701							
F 3/4" BSP			PEEK				PTFE (Teflon®)	0,1	0.2	T101A9901A
F 1" BSP										T103A9901A
F 1 1/4" BSP										T105A9901A
F 3/4" NPT										T102A9901
F 1" NPT	T104A9901									
F 1 1/4" NPT	T106A9901									



¹⁾ F = Female thread, BSP = EN ISO 228, NPT = ANSI B1.20.1

²⁾ Material: Al = Aluminium, Br = Brass, SS = Stainless Steel

³⁾ Standard seal FPM/FKM. Alternative materials, e.g. EPDM, Chemraz®, Kalrez®, NBR or HNBR on request.

Viton® and Teflon® are registered trademarks of DuPont, DuPont Elastomers.

1" (Ø 56 mm) Tank Unit (Adapter) – Male Thread

Connection ¹⁾ Inch/DN	Body Material ²⁾	Seal ³⁾	Weight ≈		Mann Tek Code No.		
		O-Ring	kg	lbs			
M ¾" BSP	Al	Standard: FPM/FKM (Viton®) Other on request.			T169A1101		
M ¾" NPT					T170A1101		
M 1" BSP					T171A1101		
M 1" NPT					T172A1101		
M ¾" BSP	Br		Standard: FPM/FKM (Viton®) Other on request.			T169A1101	
M ¾" NPT						T170A1101	
M 1" BSP						T171A1101	
M 1" NPT						T172A1101	
M ¾" BSP	SS			Standard: FPM/FKM (Viton®) Other on request.			T169A4401
M ¾" NPT							T170A4401
M 1" BSP							T171A4401
M 1" NPT							T172A4401

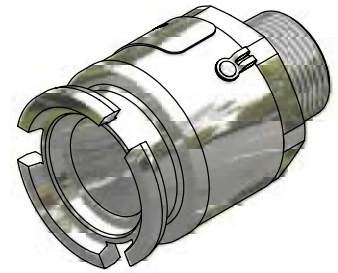

¹⁾ M = Male thread, BSP = EN ISO 228, NPT = ANSI B1.20.1

²⁾ Material: Al = Aluminium, Br = Brass, SS = Stainless Steel,

³⁾ Standard seal FPM/FKM. Alternative materials, e.g. EPDM, Chemraz®, Kalrez®, NBR or HNBR on request.

1" (Ø 56 mm) Tank Unit (Adapter) – Flanged Inlet

Flange ¹⁾	Body Material ²⁾	Seal ³⁾	Weight ≈		Mann Tek Code No.		
		O-Ring	kg	lbs			
undrilled	Al	Standard: FPM/FKM (Viton®) Other on request.	1,1	2.4	T118A1101		
DN 25 PN 10/16 Type A					T123A1101		
DN 25 PN 25/40 Type A					T124A1101		
1" ASA 150					T151A1101		
1" ASA 300					T152A1101		
undrilled	Br		Standard: FPM/FKM (Viton®) Other on request.	1,6	3.5	T118A2201	
DN 25 PN 10/16 Type B						T123A2201	
DN 25 PN 25/40 Type B						T124A2201	
1" ASA 150						T151A2201	
1" ASA 300						T152A2201	
undrilled	SS			Standard: FPM/FKM (Viton®) Other on request.	1,5	3.3	T118A4401
DN 25 PN 10/16 Type B							T123A4401
DN 25 PN 25/40 Type B							T124A4401
1" ASA 150							T151A4401
1" ASA 300							T152A4401
undrilled	Titan	Standard: FPM/FKM (Viton®) Other on request.			0,8	1.8	T118A6601
DN 25 PN 10/16 Type B							T123A6601
DN 25 PN 25/40 Type B							T124A6601
1" ASA 150							T151A6601
1" ASA 300							T152A6601
DN 25 PN 10/16 Type B	Hastelloy		Standard: FPM/FKM (Viton®) Other on request.		1,7	3.8	T123A7701
DN 25 PN 25/40 Type B							T124A7701
1" ASA 150							T151A7701
1" ASA 300							T152A7701
undrilled	PEEK				Standard: FPM/FKM (Viton®) Other on request.	0,2	0.4
DN 25 PN 10/16 Type B				T123A9901			
DN 25 PN 25/40 Type B				T124A9901			
1" ASA 150				T151A9901			
1" ASA 300				T152A9901			



¹⁾ PN 10/16/25/40 = EN 1092 (types see page 44), ANSI B16.5.

²⁾ Material: Al = Aluminium, Br = Brass, SS = Stainless Steel

³⁾ Standard seal FPM/FKM. Alternative materials, e.g. EPDM, Chemraz®, Kalrez®, NBR or HNBR on request.

Viton® is a registered trademark of DuPont, DuPont Elastomers.

1" (Ø 56 mm) Hose Unit (Coupler) – Female Thread

Connection ¹⁾ Inch/DN	Body Material ²⁾	Seal		Weight ≈		Mann Tek Code No.
		O-Ring ³⁾	Thread Seal	kg	lbs	
F 1/2" BSP	Al	Standard: FPM/FKM (Viton®)	PUR (Polyurethane)	0,5	1.1	S1133A1101B
F 3/4" BSP						S101A1101B
F 1" BSP						S103A1101B
F 1 1/4" BSP						S105A1101B
F M 54 x 1,5						S1138A1101B
F 1/2" NPT			—	S1132A1101		
F 3/4" NPT				S102A1101		
F 1" NPT				S104A1101		
F 1 1/4" NPT				S106A1101		
F 1/2" BSP				Br	Standard: FPM/FKM (Viton®)	PUR (Polyurethane)
F 3/4" BSP	S101A2201B					
F 1" BSP	S103A2201B					
F 1 1/4" BSP	S105A2201B					
F M 54 x 1,5	S1138A2201B					
F 1/2" NPT	—	S1132A2201				
F 3/4" NPT		S102A2201				
F 1" NPT		S104A2201				
F 1 1/4" NPT		S106A2201				
F 1/2" BSP		SS	Other on request.			PTFE (Teflon®)
F 3/4" BSP	S101A4401A					
F 1" BSP	S103A4401A					
F 1 1/4" BSP	S105A4401A					
F M 54 x 1,5	S1138A4401A					
F 1/2" NPT	—			S1132A4401		
F 3/4" NPT				S102A4401		
F 1" NPT				S104A4401		
F 1 1/4" NPT				S106A4401		
F 3/4" BSP				Titan	Standard: FPM/FKM (Viton®)	PTFE (Teflon®)
F 1" BSP	S103A6601A					
F 1 1/4" BSP	S105A6601A					
F 3/4" NPT	—	S102A6601				
F 1" NPT		S104A6601				
F 1 1/4" NPT		S106A6601				
F 3/4" BSP	Hastelloy	Other on request.	PTFE (Teflon®)	1,5	3.3	S101A7701A
F 1" BSP						S103A7701A
F 1 1/4" BSP						S105A7701A
F 3/4" NPT			—	S102A7701		
F 1" NPT				S104A7701		
F 1 1/4" NPT				S106A7701		
F 3/4" BSP	PEEK	Standard: FPM/FKM (Viton®)	PTFE (Teflon®)	0,3	0.7	S101A9901A
F 1" BSP						S103A9901A
F 1 1/4" BSP						S105A9901A
F 3/4" NPT			—	S102A9901		
F 1" NPT				S104A9901		
F 1 1/4" NPT				S106A9901		



¹⁾ F = Female thread, BSP = EN ISO 228, NPT = ANSI B1.20.1

²⁾ Material: Al = Aluminium, Br = Brass, SS = Stainless Steel

³⁾ Standard seal FPM/FKM. Alternative materials, e.g. EPDM, Chemraz®, Kalrez®, NBR or HNBR on request.

Viton® and Teflon® are registered trademarks of DuPont, DuPont Elastomers.

1" (Ø 56 mm) Hose Unit (Coupler) – Male Thread

Connection ¹⁾ Inch/DN	Body Material ²⁾	Seal ³⁾	Weight ≈		Mann Tek Code No.		
		O-Ring	kg	lbs			
M ¾" BSP	Al	Standard: FPM/FKM (Viton®) Other on request.			S169A1101		
M ¾" NPT					S170A1101		
M 1" BSP					S171A1101		
M 1" NPT					S172A1101		
M ¾" BSP	Br		Standard: FPM/FKM (Viton®) Other on request.			S169A1101	
M ¾" NPT						S170A1101	
M 1" BSP						S171A1101	
M 1" NPT						S172A1101	
M ¾" BSP	SS			Standard: FPM/FKM (Viton®) Other on request.			S169A4401
M ¾" NPT							S170A4401
M 1" BSP							S171A4401
M 1" NPT							S172A4401
					1,4	3.0	

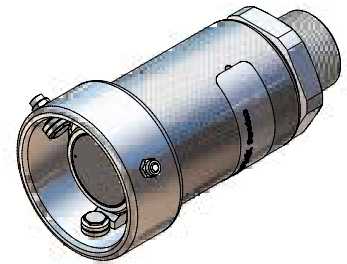

¹⁾ M = Male thread, BSP = EN ISO 228, NPT = ANSI B1.20.1

²⁾ Material: Al = Aluminium, Br = Brass, SS = Stainless Steel

³⁾ Standard seal FPM/FKM. Alternative materials,

e.g. EPDM, Chemraz®, Kalrez®, NBR or HNBR on request.

1" (Ø 56 mm) Coupler – Flanged Inlet

Flange ¹⁾	Body Material ²⁾	Seal ³⁾	Weight ≈		Mann Tek Code No.			
		O-Ring	kg	lbs				
undrilled	Al	Standard: FPM/FKM (Viton®) Other on request.	1,1	2.4	S118A1101			
DN 25 PN 10/16 Type A					S123A1101			
DN 25 PN 25/40 Type A					S124A1101			
¾" ASA 150					S149A1101			
1" ASA 150					S151A1101			
1" ASA 300					S152A1101			
DN 25 DIN 11864					S1151A1101			
undrilled	Br		Standard: FPM/FKM (Viton®) Other on request.	1,6	3.5	S118A2201		
DN 25 PN 10/16 Type B						S123A2201		
DN 25 PN 25/40 Type B						S124A2201		
¾" ASA 150						S149A2201		
1" ASA 150						S151A2201		
1" ASA 300						S152A2201		
undrilled	SS			Standard: FPM/FKM (Viton®) Other on request.	2,2	4.9	S118A4401	
DN 25 PN 10/16 Type B							S123A4401	
DN 25 PN 25/40 Type B							S124A4401	
¾" ASA 150							S149A4401	
1" ASA 150							S151A4401	
1" ASA 300	S152A4401							
undrilled	Titan				Standard: FPM/FKM (Viton®) Other on request.	1,2	2.7	S118A6601
DN 25 PN 10/16 Type B								S123A6601
DN 25 PN 25/40 Type B		S124A6601						
1" ASA 150		S151A6601						
1" ASA 300		S152A6601						
DN 25 PN 10/16 Type B	Hastelloy	Standard: FPM/FKM (Viton®) Other on request.				2,5	5.5	S123A7701
DN 25 PN 25/40 Type B								S124A7701
1" ASA 150								S151A7701
1" ASA 300								S152A7701
undrilled	PEEK		Standard: FPM/FKM (Viton®) Other on request.			0,5	1.1	S118A9901
DN 25 PN 10/16 Type B								S123A9901
DN 25 PN 25/40 Type B								S124A9901
1" ASA 150								S151A9901
1" ASA 300								S152A9901

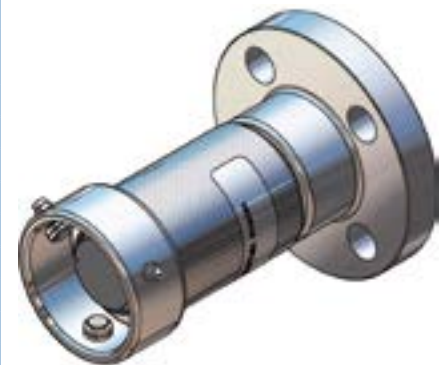

¹⁾ PN 10/16/25/40 = EN 1092 (types see page 44), ASA = ANSI B16.5 (150 o. 300 psi), 150 or 300 psi. DIN 11864 = DIN 11864-2 (aseptic flange)

²⁾ Material: Al = Aluminium, Br = Brass, SS = Stainless Steel

³⁾ Standard seal FPM/FKM. Alternative materials, e.g. EPDM, Chemraz®, Kalrez®, NBR or HNBR on request.

Viton® is a registered trademark of DuPont, DuPont Elastomers.

2" (Ø 70 mm) Technical Information

Tank Unit (Adapter) and Hose Unit (Coupler)



According to NATO STANAG 3756

Material	Maximum Working Pressure	Test Pressure	Minimum Burst Pressure
Aluminium	16 bar / 232 psi	24 bar / 348 psi	80 bar / 1160 psi
Brass/Gunmetal	16 bar / 232 psi	24 bar / 348 psi	80 bar / 1160 psi
Stainless Steel	25 bar / 363 psi	37,5 bar / 544 psi	125 bar / 1813 psi
Titan	25 bar / 363 psi	37,5 bar / 544 psi	125 bar / 1813 psi
Hastelloy	25 bar / 363 psi	37,5 bar / 544 psi	125 bar / 1813 psi
PEEK	6 bar / 87 psi	9 bar / 131 psi	30 bar / 435 psi

Connections

1½" and 2" in BSP, NPT or S60x6 thread, or flanged inlet.

Applications

For industrial process plant, road and rail tankers, ISO tank containers, IBC containers, pharmaceutical and petrochemical industries or on any application where spillage needs to be minimized.

Media

Petroleum products: gasoline, diesel, oil etc.

Chemical products: AdBlue, ethylene oxide, propylene oxide, acrylonitrile, butadiene, ammonia, vinyl chloride, toluene, xylene, sulphuric acid, phenol etc.

Gas: vapor recovery/balance systems for various media.

Dry powder.

Material of Body

Aluminium, brass/gunmetal, stainless steel, Hastelloy and PEEK. Other materials on request.

Seals

Standard seals in FPM (Viton®) - alternatively EPDM, FKM (Chemraz®, Kalrez®), NBR/HBNR. Other materials on request.

High Flow Rates / Low Pressure Drop

Allows maximum product transfer with minimal losses.

Recommended Maximum Flow Rates

900 litres/minute (fuel)

Selectivity

- avoid mixing products

To avoid product contamination caused by connecting a hose unit to the wrong tank unit, selective versions of the hose and tank units are available.

Each unit has a number of selective positions, designated by a coded part number according to the coupling size – specify when placing order. See page 32 ff.

Interchangeability

Compatible with couplings of other manufacturers.

Hose Unit with Integrated Swivel

All hose units are supplied with an integrated swivel.

2" (Ø 70 mm) Tank Unit (Adapter) – Female Thread

Connection ¹⁾ Inch/DN	Body Material ²⁾	Seal		Weight ≈		Mann Tek Code No.			
		O-Ring ³⁾	Thread Seal	kg	lbs				
F 1½" BSP	Al	Standard: FPM/FKM (Viton®)	PUR (Polyurethane)	0,4	0.8	T207A1101B			
F 2" BSP						T210A1101B			
F S60x6						T2108A1101B			
F W2" - 7						T2112A1101B			
F 1½" NPT	Al		Other on request.	—	0.4	0.8	T208A1101		
F 2" NPT							T211A1101		
F 1½" BSP	Br			Other on request.	PUR (Polyurethane)	1,2	2.7	T207A2201B	
F 2" BSP								T210A2201B	
F S60 x 6								T2108A2201B	
F W2" - 7								T2112A2201B	
F 1½" NPT	Br				Other on request.	—	0.4	0.9	T208A2201
F 2" NPT									T211A2201
F 1½" BSP	SS	Other on request.				PTFE (Teflon®)	1,1	2.4	T207A4401A
F 2" BSP									T210A4401A
F S60 x 6									T2108A4401A
F 1½" NPT	SS					Other on request.	—	1,2	2.7
F 2" NPT			T211A4401						
F 1½" BSP	Titan		Other on request.				PTFE (Teflon®)	0,6	1.3
F 2" BSP				T210A6601A					
F 1½" NPT				T208A6601					
F 2" NPT				T211A6601					
F 1½" BSP	Hastelloy			Other on request.			PTFE (Teflon®)	0,6	1.3
F 2" BSP					T210A7701A				
F 1½" NPT					T208A7701				
F 2" NPT		T211A7701							
F 1½" BSP	PEEK	Other on request.			PTFE (Teflon®)		0,3	0.6	T207A9901A
F 2" BSP									T210A9901A
F 1½" NPT						T208A9901			
F 2" NPT						T211A9901			

According to
NATO STANAG 3756



¹⁾ F = Female thread, BSP = EN ISO 228, NPT = ANSI B1.20.1, S60 x 6 = thread for IBC, W 2" heating oil connection Sweden

²⁾ Material: Al = Aluminium, Br = Brass, SS = Stainless Steel

³⁾ Standard seal FPM/FKM. Alternative materials, e. g. EPDM, Chemraz®, Kalrez®, NBR or HNBR on request.

2" (Ø 70 mm) Tank Unit (Adapter) – Male Thread

Flange ¹⁾	Body Material ²⁾	Seal ³⁾	Weight ≈		Mann Tek Code No.	
		O-Ring	kg	lbs		
M 2" BSP	Al	Standard: FPM/FKM (Viton®)	1,0	2.2	T278A1101	
M 2" NPT					T279A1101	
M W2" - 7					T2123A1101	
M 2" BSP	Br		Other on request.	1,0	2.2	T278A2201
M 2" NPT						T279A2201
M W2" - 7						T2123A2201
M 2" BSP	SS	Other on request.		1,0	2.2	T278A4401
M 2" NPT						T279A4401

According to
NATO STANAG 3756



¹⁾ M = Male thread, BSP = EN ISO 228, NPT = ANSI B1.20.1, S60 x 6 = thread for IBC, W 2" heating oil connection Sweden

²⁾ Material: Al = Aluminium, Br = Brass, SS = Stainless Steel

³⁾ Standard seal FPM/FKM. Alternative materials, e. g. EPDM, Chemraz®, Kalrez®, NBR or HNBR on request.

Viton® is a registered trademark of DuPont, DuPont Elastomers.

2" (Ø 70 mm) Tank Unit (Adapter) – Flanged Inlet

Flange ¹⁾	Body Material ²⁾	Seal ³⁾	Weight ≈		Mann Tek Code No.	
		O-Ring	kg	lbs		
undrilled Ø 165 mm	AI	Standard: FPM/FKM (Viton®)	1,0	2,2	T219B1101	
DN 40 PN 10/16 Type A			0,9	2,0	T227B1101	
1½" ASA 150			0,8	1,8	T255B1101	
DN 50 PN 10/16 Type A			1,0	2,2	T230B1101	
2" ASA 150			0,9	2,0	T257B1101	
DIN 28459 'TW 1' / DN 80			0,9	2,0	T265B1101	
undrilled Ø 165 mm	GM		3,3	7,3	T219B2201	
DN 40 PN 10/16 Type B			2,5	5,5	T227B2201	
DN 40 PN 25/40 Type B					T228B2201	
1½" ASA 150			2,2	4,9	T255B2201	
1½" ASA 300					T256B2201	
DN 50 PN 10/16 Type B			3,1	6,8	T230B2201	
DN 50 PN 25/40 Type B					T231B2201	
2" ASA 150			2,5	5,1	T257B2201	
2" ASA 300					T258B2201	
DIN 28459 'TW 1' / DN 80			2,4	5,3	T265B2201	
undrilled Ø 165 mm			SS	3,2	7,1	T219B4401
undrilled Ø 165 mm **)						T219B4401F
DN 40 PN 10/16 Type B	2,4			5,3	T227B4401	
DN 40 PN 10/16 Type B **)					T227B4401F	
DN 40 PN 25/40 Type B	2,4			5,3	T228B4401	
DN 40 PN 25/40 Type B **)					T228B4401F	
1½" ASA 150	1,7			3,8	T255B4401	
1½" ASA 150 **)					T255B4401F	
1½" ASA 300	2,1	4,6		T256B4401		
1½" ASA 300 **)				T256B4401F		
DN 50 PN 25/40 Type E *)	2,9	6,4		T229B4401		
DN 50 PN 10/16 Type B	2,7	6,0		T230B4401		
DN 50 PN 10/16 Type B **)				T230B4401F		
DN 50 PN 25/40 Type B	3,0	6,6		T231B4401		
DN 50 PN 25/40 Type B **)				T231B4401F		
2" ASA 150	2,4	5,3		T257B4401		
2" ASA 150 **)				T257B4401F		
2" ASA 300	2,5	5,5		T258B4401		
2" ASA 300 **)				T258B4401F		
DIN 28459 'TW 1' / DN 80				T265B4401		
DN 50 DIN 11864				T2152B4401		
undrilled Ø 165 mm	Titan				T219A6601	
DN 40 PN 10/16 Type B					T227A6601	
DN 40 PN 25/40 Type B					T228A6601	
1½" ASA 150		1,7	3,8	T255A6601		
1½" ASA 300				T256A6601		
DN 50 PN 10/16 Type B				T230A6601		
DN 50 PN 25/40 Type B				T231A6601		
2" ASA 150				T257A6601		
2" ASA 300			T258A6601			
undrilled Ø 165 mm	Hastelloy			T219A7701		
DN 40 PN 10/16 Type B				T227A7701		
DN 40 PN 25/40 Type B				T228A7701		
1½" ASA 150				T255A7701		
1½" ASA 300 B				T256A7701		
DN 50 PN 10/16 Type B				T230A7701		
DN 50 PN 25/40 Type B				T231A7701		
2" ASA 150				T257A7701		
2" ASA 300			T258A7701			
undrilled Ø 165 mm	PEEK			T219A9901		
DN 40 PN 10/16 Type B		1,0	2,0	T227A9901		
1½" ASA 150				T255A9901		
DN 50 PN 10/16 Type B		1,0	2,0	T230A9901		
2" ASA 150		1,0	2,0	T257A9901		

According to
NATO STANAG 3756



*) Type E (with spigot),
EN 1092-1, see p. 44

***) Flange with standard thickness

1) PN 10/16/25/40 = EN 1092
(types see page 44),
ASA = ANSI B16.5 (150 o. 300 psi),
DIN 28459 = old standard TW, 10 bar.
DIN 11864 = DIN 11864-2 (aseptic flange)

2) Material: AI = Aluminium,
GM = Gunmetal, SS = Stainless Steel

3) Standard seal FPM/FKM. Alternative
materials, e.g. EPDM, Chemraz®,
Kalrez®, NBR or HNBR on request.

Viton® is a registered trademark of
DuPont, DuPont Elastomers.

2" (Ø 70 mm) Hose Unit (Coupler) – Female Thread

Connection ¹⁾ Inch/DN	Body Material ²⁾	Seal		Weight ≈		Mann Tek Code No.	
		O-Ring ³⁾	Thread Seal	kg	lbs		
F 1½" BSP	Al	Standard: FPM/FKM (Viton®)	PUR (Polyurethane)	1,2	2,7	S207A1101B	
F 1½" BSP-B Mouth*)						S207A1101BI	
F 2" BSP				1,1	2,4	S210A1101B	
F 2" BSP-B Mouth*)				1,1	2,4	S210A1101BI	
F 1½" NPT			-	1,1	2,4	S208A1101	
F 1½" NPT-B Mouth*)						S208A1101I	
F 2" NPT				1,1	2,4	S211A1101	
F 2" NPT-B Mouth*)						S211A1101I	
F 1½" BSP	Br		Other on request.	PUR (Polyurethane)	2,6	5,7	S207A2201B
F 1½" BSP-B Mouth*)							S207A2201BI
F 2" BSP					2,4	5,3	S210A2201B
F 2" BSP-B Mouth*)							S210A2201BI
F 1½" NPT				-	2,5	5,5	S208A2201
F 1½" NPT-B Mouth*)							S208A2201I
F 2" NPT					2,5	5,5	S211A2201
F 2" NPT-B Mouth*)							S211A2201I
F 1½" BSP	SS	-	PTFE (Teflon®)	2,5	5,5	S207A4401A	
F 2" BSP				2,3	5,1	S210A4401A	
F 1½" NPT			-	2,4	5,3	S208A4401	
F 2" NPT				2,3	5,1	S211A4401	
F 1½" BSP	Titan	-	PTFE (Teflon®)	1,3	2,9	S207A6601A	
F 2" BSP				1,3	2,9	S210A6601A	
F 1½" NPT			-			S208A6601	
F 2" NPT				1,4	3,1	S211A6601	
F 1½" BSP	Hastelloy	-	PTFE (Teflon®)	2,3	5,1	S207A7701A	
F 2" BSP				2,3	5,1	S210A7701A	
F 1½" NPT			-	2,3	5,1	S208A7701	
F 2" NPT				2,3	5,1	S211A7701	
F 1½" BSP	PEEK	-	PTFE (Teflon®)	1,3	2,9	S207A9901A	
F 2" BSP						S210A9901A	
F 1½" NPT			-			S208A9901	
F 2" NPT				1,3	2,9	S211A9901	

According to
NATO STANAG 3756



*) Adopted for older models of
Emco Wheaton male couplings

1) F = Female thread, BSP =
EN ISO 228, NPT = ANSI B1.20.1

2) Material: Al = Aluminium, Br = Brass,
SS = Stainless Steel

3) Standard seal FPM/FKM. Alternative
materials, e.g. EPDM, Chemraz®,
Kalrez®, NBR or HNBR on request.

2" (Ø 70 mm) Hose Unit (Coupler) – Male Thread

Flange ¹⁾	Body Material ²⁾	Seal ³⁾	Weight ≈		Mann Tek Code No.			
		O-Ring	kg	lbs				
2" BSP AG	Al	Standard: FPM/FKM (Viton®)			S278A1101			
2" NPT AG					S279A1101			
S60 x 6 AG					S2109A1101			
W2" - 7 AG					1,3	2,1	S2123A1101	
2" BSP AG	Br		Other on request.			S278A2201		
2" NPT AG						S279A2201		
S60x6 AG						S2109A2201		
W2" - 7 AG						S2123A2201		
2" BSP AG	SS	-				2,3	5,1	S278A4401
2" NPT AG						S279A4401		
S60x6 AG						S2109A4401		

According to
NATO STANAG 3756



1) M = Male thread, BSP = EN ISO 228, NPT = ANSI B1.20.1, S60 x 6 = thread for IBC, W 2" heating oil connection Sweden

2) Material: Al = Aluminium, Br = Brass, SS = Stainless Steel

3) Standard seal FPM/FKM. Alternative materials, e.g. EPDM, Chemraz®, Kalrez®, NBR or HNBR on request.

Viton® and Teflon® are registered trademarks of DuPont, DuPont Elastomers.

2" (Ø 70 mm) Coupler – Flanged Inlet

Flange ¹⁾	Body Material ²⁾	Seal ³⁾	Weight ≈		Mann Tek Code No.	
		O-Ring	kg	lbs		
undrilled Ø 165 mm	AI	Standard: FPM/FKM (Viton®) Other on request.			S219A1101	
DN 40 PN 10/16 Type A						S227A1101
1½" ASA 150						S255A1101
DN 50 PN 10/16 Type A			2,3	5.1		S230A1101
2" ASA 150						S257A1101
DIN 28459 'TW 1' / DN 80						S265A1101
undrilled Ø 165 mm	GM					S219A2201
DN 40 PN 10/16 Type B						S227A2201
DN 40 PN 25/40 Type B						S228A2201
1½" ASA 150			5,1	11.2		S255A2201
1½" ASA 300						S256A2201
DN 50 PN 10/16 Type B						S230A2201
DN 50 PN 25/40 Type B						S231A2201
2" ASA 150			5,1	11.2		S257A2201
2" ASA 300						S258A2201
DIN 28459 'TW 1' / DN 80						S265A2201
undrilled Ø 165 mm	SS					S219A4401
o. Bohrungen Ø 165 mm **)						S219A4401F
DN 40 PN 10/16 Type B						S227A4401
DN 40 PN 10/16 Type B **)						S227A4401F
DN 40 PN 25/40 Type B						S228A4401
DN 40 PN 25/40 Type B **)						S228A4401F
1½" ASA 150						S255A4401
1½" ASA 150 **)						S255A4401F
1½" ASA 300					S256A4401	
1½" ASA 300 **)		6,6	14.6		S256A4401F	
DN 50 PN 25/40 Type E *)					S229A4401	
DN 50 PN 10/16 Type B		5,4	11.9		S230A4401	
DN 50 PN 10/16 Type B **)					S230A4401F	
DN 50 PN 25/40 Type B		5,4	11.9		S231A4401	
DN 50 PN 25/40 Type B **)					S231A4401F	
2" ASA 150		5,1	11.2		S257A4401	
2" ASA 150 **)		5,1	11.2		S257A4401F	
2" ASA 300					S258A4401	
2" ASA 300 **)		2,5	5.5		S258A4401F	
DIN 28459 'TW 1' / DN 80					S265A4401	
DN 50 DIN 11864	3,1	6.8		S2152B4401		
undrilled Ø 165 mm	Titan				S219A6601	
DN 40 PN 10/16 Type B					S227A6601	
DN 40 PN 25/40 Type B					S228A6601	
1½" ASA 150					S255A6601	
1½" ASA 300					S256A6601	
DN 50 PN 10/16 Type B					S230A6601	
DN 50 PN 25/40 Type B					S231A6601	
2" ASA 150					S257A6601	
2" ASA 300				S258A6601		
undrilled Ø 165 mm	Hastelloy				S219A7701	
DN 40 PN 10/16 Type B					S227A7701	
DN 40 PN 25/40 Type B					S228A7701	
1½" ASA 150					S255A7701	
1½" ASA 300					S256A7701	
DN 50 PN 10/16 Type B		5,4	11.9		S230A7701	
DN 50 PN 25/40 Type B					S231A7701	
2" ASA 150					S257A7701	
2" ASA 300				S258A7701		
undrilled Ø 165 mm	PEEK				S219A9901	
DN 40 PN 10/16 Type B		5,4	11.9		S227A9901	
1½" ASA 150 Type B					S255A9901	
DN 50 PN 10/16 Type B		5,4	11.9		S230A9901	
2" ASA 150				S257A9901		

According to
NATO STANAG 3756

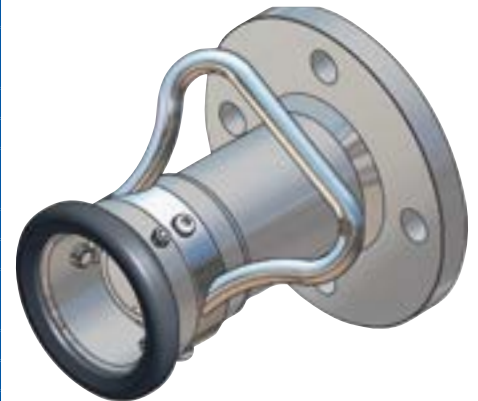

*) Type E (with spigot),
EN 1092-1, see page 44

***) Flange with standard thickness

1) PN 10/16/25/40 = EN 1092
(types see page 44),
ASA = ANSI B16.5 (150 o. 300 psi),
DIN 28459 = old standard TW, 10 bar.
DIN 11864 = DIN 11864-2 (aseptic flange).

2) Material: AI = Aluminium,
GM = Gunmetal, SS = Stainless Steel

3) Standard seal FPM/FKM. Alternative
materials, e.g. EPDM, Chemraz®,
Kalrez®, NBR or HNBR on request.

Viton® is a registered trademark of
DuPont, DuPont Elastomers.

2½" (Ø 105 mm) Technical Information

Tank Unit (Adapter) and Hose Unit (Coupler)



According to NATO STANAG 3756

Material	Maximum Working Pressure	Test Pressure	Minimum Burst Pressure
Aluminium	10 bar / 145 psi	15 bar / 218 psi	50 bar / 726 psi
Brass/Gunmetal	16 bar / 232 psi	24 bar / 348 psi	80 bar / 1160 psi
Stainless Steel	25 bar / 363 psi	37,5 bar / 544 psi	125 bar / 1813 psi
Titan	25 bar / 363 psi	37,5 bar / 544 psi	125 bar / 1813 psi
Hastelloy	25 bar / 363 psi	37,5 bar / 544 psi	125 bar / 1813 psi
PEEK	6 bar / 87 psi	9 bar / 131 psi	30 bar / 435 psi

Connections

2½" and 3" in BSP, NPT and flanged inlet.

Applications

For road and rail tanker bottom loading/unloading, tanks and containers, or on any application where product contamination and spillage needs to be minimized.

Media

Petroleum products: gasoline, diesel, oil etc.

Chemical products: ethylene oxide, propylene oxide, acrylonitrile, butadiene, ammonia, vinyl chloride, toluene, xylene, sulphuric acid, phenol etc.

Gas: vapor recovery/balance systems for various media.

Dry powder

Material of Body

Aluminium, brass/gunmetal, stainless steel, Hastelloy and PEEK. Other materials on request.

Seals

Standard seals in FPM (Viton®), EPDM, Chemraz®, Kalrez®, NBR. Other materials on request.

High Flow Rates / Low Pressure Drop

Allows maximum product transfer with minimal losses.

Recommended Maximum Flow Rates

1500 litres/minute (fuel)

Selectivity

- avoid mixing products

To avoid product contamination caused by connecting a hose unit to the wrong tank unit, selective versions of the hose and tank units are available.

Each unit has a number of selective positions, designated by a coded part number according to the coupling size – specify when placing order. See page 32 ff.

Interchangeability

Compatible with couplings of other manufacturers.

Hose Unit with Integrated Swivel

All hose units are supplied with an integrated swivel.

2½" (Ø 105 mm) Tank Unit (Adapter) – Female Thread

Connection ¹⁾ Inch/DN	Body Material ²⁾	Seal		Weight ≈		Mann Tek Code No.		
		O-Ring ³⁾	Thread Seal	kg	lbs			
F 2½" BSP	AI	Standard: FPM/FKM (Viton®)	PUR (Polyurethane)	1,0	2,2	T312D1101B		
F 3" BSP			(Polyurethane)	1,0	2,2	T314D1101B		
F 2½" NPT			—	1,0	2,2	T313D1101		
F 3" NPT			—	1,1	2,4	T315D1101		
F 2½" BSP	GM		Other on request.	PUR (Polyurethane)	2,7	6,0	T312D2201B	
F 3" BSP				(Polyurethane)	2,9	6,4	T314D2201B	
F 2½" NPT				—	2,9	6,4	T313D2201	
F 3" NPT				—	3,2	7,1	T315D2201	
F 2½" BSP	SS			Other on request.	PTFE (Teflon®)	2,5	5,5	T312B4401A
F 3" BSP					(Teflon®)	3,1	6,8	T314B4401A
F 2½" NPT					—	2,7	6,0	T313B4401
F 3" NPT					—	3,7	8,2	T315B4401
F 2½" BSP	Hastelloy	Other on request.			PTFE (Teflon®)	2,6	5,7	T312A7701A
F 3" BSP					(Teflon®)			T314A7701A
F 2½" NPT					—			T313A7701
F 3" NPT					—			T315A7701
F 2½" BSP	PEEK		Other on request.		PTFE (Teflon®)			T312A9901A
F 3" BSP					(Teflon®)			T314A9901A
F 2½" NPT					—			T313A9901
F 3" NPT					—			T315A9901

According to
NATO STANAG 3756



¹⁾ F = Female thread, BSP = EN ISO 228, NPT = ANSI B1.20.1

²⁾ Material: AI = Aluminium, GM = Gunmetal, SS = Stainless Steel

³⁾ Standard seal FPM/FKM. Alternative materials, e. g. EPDM, Chemraz®, Kalrez®, NBR or HNBR on request.

Viton® and Teflon® are registered trademarks of DuPont, DuPont Elastomers.

2½" (Ø 105 mm) Tank Unit (Adapter) – Male Thread

Connection ¹⁾ Inch/DN	Body Material ²⁾	Seal ³⁾	Weight ≈		Mann Tek Code No.			
		O-Ring	kg	lbs				
2½" BSP	AI	Standard: FPM/FKM (Viton®)		1,0	2,2	T380A1101		
3" BSP						T382A1101		
2½" NPT						T381A1101		
3" NPT						T383A1101		
2½" BSP	GM		Other on request.				T380A2201	
3" BSP							T382A2201	
2½" NPT							T381A2201	
3" NPT							T383A2201	
2½" BSP	SS			Other on request.				T380A4401
3" BSP								T382A4401
2½" NPT								T381A4401
3" NPT								T383A4401

According to
NATO STANAG 3756



¹⁾ M = Male thread, BSP = EN ISO 228, NPT = ANSI B1.20.1

²⁾ Material: AI = Aluminium, GM = Gunmetal, SS = Stainless Steel

³⁾ Standard seal FPM/FKM. Alternative materials, e. g. EPDM, Chemraz®, Kalrez®, NBR or HNBR on request.

Viton® and Teflon® are registered trademarks of DuPont, DuPont Elastomers.

2½" (Ø 105 mm) Tank Unit (Adapter) – Flanged Inlet

Flange ¹⁾	Body Material ²⁾	Seal ³⁾	Weight ≈		Mann Tek Code No.
		O-Ring	kg	lbs	
undrilled Ø 210 mm	AI	Standard: FPM/FKM (Viton®)	2,1	4,6	T320D1101
DN 65 PN 10/16 Type A			1,6	3,5	T333D1101
DN 80 PN 10/16 Type A			1,8	4,0	T336D1101
2½" ASA 150			1,7	3,8	T359D1101
3" ASA 150			1,8	4,0	T361D1101
DIN 28459 'TW 1' / DN 80			1,3	2,9	T365D1101
DIN 28459 'TW 3' / DN 100			1,7	3,8	T366D1101
3" TTMA			1,4	3,1	T367D1101
4" TTMA			1,5	3,3	T368D1101
undrilled Ø 210 mm			GM	Standard: FPM/FKM (Viton®)	6,2
DN 65 PN 10/16 Type B	4,9	10,8			T333D2201
DN 65 PN 25/40 Type B					T334D2201
DN 80 PN 10/16 Type B					T336D2201
DN 80 PN 25/40 Type B					T337D2201
2½" ASA 150	4,4	9,7			T359D2201
2½" ASA 300					T360D2201
3" ASA 150	4,4	9,7			T361D2201
3" ASA 300					T362D2201
DIN 28459 'TW 1' / DN 80	4,4	9,7			T365D2201
DIN 28459 'TW 3' / DN 100			T366D2201		
3" TTMA			T367D2201		
4" TTMA			T368D2201		
undrilled Ø 210 mm	SS	Other on request.			T320B4401
o. Bohrungen Ø 210 mm **)					T320B4401F
DN 65 PN 25/40 Type E *)					T332B4401
DN 65 PN 10/16 Type B			4,2	9,3	T333B4401
DN 65 PN 10/16 Type B **)					T333B4401F
DN 65 PN 25/40 Type B			4,3	9,5	T334B4401
DN 65 PN 25/40 Type B **)			4,3	9,5	T334B4401F
DN 80 PN 10/16 Type E *)					T335B4401
DN 80 PN 10/16 Type B			4,7	10,4	T336B4401
DN 80 PN 10/16 Type B **)					T336B4401F
DN 80 PN 25/40 Type B					T337B4401
DN 80 PN 25/40 Type B **)					T337B4401F
2½" ASA 150			4,0	8,8	T359B4401
2½" ASA 150 **)					T359B4401F
2½" ASA 300			4,5	9,9	T360B4401
2½" ASA 300 **)			4,5	9,9	T360B4401F
3" ASA 150			4,5	9,9	T361B4401
3" ASA 150 **)					T361B4401F
3" ASA 300					T362B4401
3" ASA 300 **)					T362B4401F
DIN 28459 'TW 1' / DN 80			T365B4401		
DIN 28459 'TW 3' / DN 100			T366B4401		
3" TTMA			T367B4401		
4" TTMA			T368B4401		

According to
NATO STANAG 3756



*) Type E (with spigot), EN 1092-1, see page 44

***) Flange with standard thickness

1) PN 10/16/25/40 = EN 1092 (types see page 44), ASA = ANSI B16.5 (150 o. 300 psi), DIN 28459 = old standard TW, 10 bar. TTMA = Standard of the Truck Trailer Manufacturers Association

2) Material: AI = Aluminium, GM = Gunmetal, SS = Stainless Steel

3) Standard seal FPM/FKM. Alternative materials, e.g. EPDM, Chemraz®, Kalrez®, NBR or HNBR on request.

Viton® is a registered trademark of DuPont, DuPont Elastomers.

2½" (Ø 105 mm) Tank Unit (Adapter) with Square Flange Connection

Flange ¹⁾	Body Material ²⁾	Seal ³⁾	Weight ≈		Mann Tek Code No.
		O-Ring	kg	lbs	
Normec (120 x 120 mm)	AI	Standard: FPM/FKM (Viton®)			T3107D1101
Normec (120 x 120 mm)	GM				T3107D2201

According to
NATO STANAG 3756



1) Normec = with drilling for Italian road tanker connection

2) Material: AI = Aluminium, GM = Gunmetal

3) Standarddichtung FPM/FKM. Alternative Materialien, z.B. EPDM, Chemraz®, Kalrez®, NBR oder HNBR auf Anfrage

Viton® is a registered trademark of DuPont, DuPont Elastomers.

2½" (Ø 105 mm) Hose Unit (Coupler) – Female Thread

Connection ¹⁾ Inch/DN	Body Material ²⁾	Seal		Weight ≈		Mann Tek Code No.	
		O-Ring ³⁾	Thread Seal	kg	lbs		
F 2½" BSP	Al	Standard: FPM/FKM (Viton®)	PUR (Polyurethan)	3,3	7,3	S312B1101B	
F 3" BSP				3,6	7,9	S314B1101B	
F 2½" NPT			–	3,4	7,5	S313B1101	
F 3" NPT				3,5	7,7	S315B1101	
F 2½" BSP	GM		PUR (Polyurethan)	7,3	16,1	S312B2201B	
F 3" BSP				7,4	16,3	S314B2201B	
F 2½" NPT			–			S313B2201	
F 3" NPT	SS		Other on request.	PTFE	6,7	14,8	S312B4401A
F 2½" BSP					6,6	14,6	S314B4401A
F 3" BSP				–	6,6	14,6	S313B4401
F 2½" NPT					6,6	14,6	S315B4401
F 2½" BSP	Hastelloy			PTFE	6,8	15,0	S312A7701A
F 3" BSP						S314A7701A	
F 2½" NPT		–				S313A7701	
F 3" NPT	PEEK			PTFE			S312A9901A
F 2½" BSP						S314A9901A	
F 3" BSP			–			S313A9901	
F 2½" NPT						S315A9901	
F 3" NPT							

According to
NATO STANAG 3756



2½" (Ø 105 mm) Coupler – Flanged Inlet

Flange ^{1B)}	Body Material ²⁾	Seal ³⁾	Weight ≈		Mann Tek Code No.		
		O-Ring	kg	lbs			
undrilled Ø 210 mm	Al	Standard: FPM/FKM (Viton®)			S320B1101		
DN 65 PN 10/16 Type A			10,0	22,1	S333B1101		
DN 80 PN 10/16 Type A					S336B1101		
2" ASA 150					S357B1101		
2½" ASA 150					S359B1101		
3" ASA 150					S361B1101		
DIN 28459 'TW 1' / DN 80					S365B1101		
DIN 28459 'TW 3' / DN 100					S366B1101		
3" TTMA					S367B1101		
4" TTMA					S368B1101		
undrilled Ø 210 mm			GM	S320B2201			S320B2201
DN 65 PN 10/16 Type B						S333B2201	
DN 65 PN 25/40 Type B					S334B2201		
DN 80 PN 10/16 Type B					S336B2201		
DN 80 PN 25/40 Type B					S337B2201		
2" ASA 150					S357B2201		
2½" ASA 150					S359B2201		
2½" ASA 300					S360B2201		
3" ASA 150					S361B2201		
3" ASA 300					S362B2201		
DIN 28459 'TW 1' / DN 80					S365B2201		
DIN 28459 'TW 3' / DN 100					S366B2201		
3" TTMA				S367B2201			
4" TTMA				S368B2201			
undrilled Ø 210 mm	SS	Other on request.			S320B4401		
undrilled Ø 210 mm ^{**)}					S320B4401F		
DN 65 PN 25/40 Type E ^{*)}			10,0	22,1	S332B4401		
DN 65 PN 10/16 Type B					S333B4401		
DN 65 PN 10/16 Type B ^{**)}					S333B4401F		
DN 65 PN 25/40 Type B					S334B4401		
DN 65 PN 25/40 Type B ^{**)}					S334B4401F		
DN 80 PN 10/16 Type E ^{*)}					S335B4401		
DN 80 PN 10/16 Type B					S336B4401		
DN 80 PN 10/16 Type B ^{**)}					S336B4401F		
DN 80 PN 25/40 Type B					S337B4401		
DN 80 PN 25/40 Type B ^{**)}					S337B4401F		
2" ASA 150					S357B4401		
2" ASA 150 ^{**)}					S357B4401F		
2½" ASA 150			6,6	14,6	S359B4401		
2½" ASA 150 ^{**)}			6,6	14,6	S359B4401F		
2½" ASA 300					S360B4401		
2½" ASA 300 ^{**)}					S360B4401F		
3" ASA 150					S361B4401		
3" ASA 150 ^{**)}					S361B4401F		
3" ASA 300					S362B4401		
3" ASA 300 ^{**)}					S362B4401F		
DIN 28459 'TW 1' / DN 80					S365B4401		
DIN 28459 'TW 3' / DN 100					S366B4401		
3" TTMA			S367B4401				
4" TTMA			S368B4401				

According to
NATO STANAG 3756



^{*)} Type E (with spigot),
EN 1092-1, see page 44

^{**)} Flange with standard thickness

^{1A)} F = Female thread, BSP = EN ISO 228,
NPT = ANSI B1.20.1

^{1B)} PN 10/16/25/40 = EN 1092
(types see page 44),
ASA = ANSI B16.5 (150 o. 300 psi),
DIN 28459 = old standard TW, 10 bar.
TTMA = Truck Trailer Manufacturers Association

²⁾ Material: Al = Aluminium, GM = Gunmetal,
SS = Stainless Steel

³⁾ Standard seal FPM/FKM. Alternative
materials, e. g. EPDM, Chemraz®, Kalrez®,
NBR or HNBR on request

Viton® and Teflon® are registered
trademarks of DuPont, DuPont Elastomers.

3" (Ø 119 mm) Technical Information

Tank Unit (Adapter) and Hose Unit (Coupler)



According to NATO STANAG 3756

Material	Maximum Working Pressure	Test Pressure	Minimum Burst Pressure
Aluminium	10 bar / 145 psi	15 bar / 218 psi	50 bar / 726 psi
Brass/Gunmetal	16 bar / 232 psi	24 bar / 348 psi	80 bar / 1160 psi
Stainless Steel	25 bar / 363 psi	37,5 bar / 544 psi	125 bar / 1813 psi
Titan	25 bar / 363 psi	37,5 bar / 544 psi	125 bar / 1813 psi
Hastelloy	25 bar / 363 psi	37,5 bar / 544 psi	125 bar / 1813 psi
PEEK	6 bar / 87 psi	9 bar / 131 psi	30 bar / 435 psi

Connections

3" in BSP, NPT and flanged inlet.

Applications

For road, rail tanker loading/unloading, filling of tanks and containers, refuelling and loading/unloading bunker boats (marine tankers) and small ships.

Also suitable for other applications where high loading rates are required and product contamination and spillage needs to be minimized.

Media

Petroleum products: gasoline, diesel, oil etc.

Chemical products: ethylene oxide, propylene oxide, acrylonitrile, butadiene, ammonia, vinyl chloride, toluene, xylene, sulphuric acid, phenol etc.

Gas: vapor recovery/balance systems

Dry powder.

Material of Body

Aluminium, brass/gunmetal, stainless steel, Hastelloy and PEEK. Other materials on request.

Seals

Standard seals FPM (Viton®), EPDM, FFKM (Chemraz®, Kalrez®), NBR. Other on request.

High Flow Rates / Low Pressure Drop

Allows maximum product transfer with minimal losses.

Recommended Maximum Flow Rates

2000 litres/minute (fuel)

Selectivity

- avoid mixing products

To avoid product contamination caused by connecting a hose unit to the wrong tank unit, selective versions of the hose and tank units are available.

Each unit has a number of selective positions, designated by a coded part number according to the coupling size – specify when placing order.

Interchangeability

Compatible with couplings of other manufacturers.

Hose Unit with Integrated Swivel

All hose units are supplied with an integrated swivel.

3" (Ø 119 mm) Tank Unit (Adapter) – Female Thread

Connection ¹⁾ Inch/DN	Body Material ²⁾	Seal		Weight ≈		Mann Tek Code No.	
		O-Ring ³⁾	Thread Seal	kg	lbs		
F 3" BSP	Al	Standard: FPM/FKM (Viton®)	PUR	1,2	2,7	T414D1101B	
F 3" BSP				1,3	2,9	T414K1101B*)	
F 3" NPT				1,2	2,7	T415D1101	
F 3" BSP	GM		Other on request.	PUR	3,2	7,1	T414D2201B
F 3" NPT					3,5	7,7	T415D2201
F 3" BSP	Br			PUR	1,3	2,9	T414K2201B*)
F 3" BSP					SS	PTFE	3,1
F 3" NPT	3,4			7,5			T415B4401
F 3" BSP	Hastelloy			PTFE			T414A7701A
F 3" NPT							T415A7701
F 3" BSP	PVDF/Hastelloy			PTFE	3,6	7,9	T414A8701A
F 3" BSP					PEEK	PTFE	
F 3" NPT							

According to
NATO STANAG 3756



3" (Ø 119 mm) Tank Unit (Adapter) – Flanged Inlet

Flange ^{1B)}	Body Material ²⁾	Seal ³⁾	Weight ≈		Mann Tek Code No.		
		O-Ring	kg	lbs			
undrilled Ø 210 mm	Al	Standard: FPM/FKM (Viton®)	2,0	4,4	T420D1101		
DN 65 PN 10 / 16 Type A					T433D1101		
DN 80 PN 10/16 Type A			2,0	4,4	T436D1101		
3" ASA 150			1,8	4,0	T461D1101		
DIN 28459 'TW 1' / DN 80			1,4	3,1	T465D1101		
DIN 28459 'TW 3' / DN 100			1,6	3,5	T466D1101		
3" TTMA			1,8	4,0	T467D1101		
4" TTMA			1,5	3,3	T468D1101		
undrilled Ø 210 mm			GM	Other on request.	6,2	13,7	T320D2201
DN 65 PN 10/16 Type B					4,9	10,8	T433D2201
DN 65 PN 25/40 Type B						T434D2201	
DN 80 PN 10/16 Type B	5,2				11,5	T436D2201	
DN 80 PN 25/40 Type B					T437D2201		
3" ASA 150	4,9	10,8			T461D2201		
3" ASA 300					T462D2201		
DIN 28459 'TW 1' / DN 80	4,1	9,0			T465D2201		
DIN 28459 'TW 3' / DN 100	4,7	10,4			T466D2201		
3" TTMA					T467D2201		
4" TTMA	4,6	10,1	T468D2201				
undrilled Ø 210 mm	SS	Other on request.				T420B4401	
undrilled Ø 210 mm***)					T420B4401F		
DN 65 PN 10/16 Type B					T433B4401		
DN 65 PN 10/16 Type B***)					T433B4401F		
DN 65 PN 25/40 Type B					T434B4401		
DN 65 PN 25/40 Type B***)					T434B4401F		
DN 80 PN 25/40 Type E**)					T435B4401F		
DN 80 PN 10/16 Type B			5,1	11,2	T436B4401		
DN 80 PN 10/16 Type B***)					T436B4401F		
DN 80 PN 25/40 Type B			5,1	11,2	T437B4401		
DN 80 PN 25/40 Type B***)				T437B4401F			
3" ASA 150	4,9		10,8	T461B4401			
3" ASA 150***)		14,1	T461B4401F				
3" ASA 300	4,9	10,8	T462B4401				
3" ASA 300***)			T462B4401F				
DIN 28459 'TW 1' / DN 80	3,9	8,6	T465B4401				
DIN 28459 'TW 3' / DN 100			T466B4401				
3" TTMA			T467B4401				
4" TTMA			T468B4401				
undrilled Ø 210 mm	PEEK				T420A9901		
DN 80 PN 10/16 Type B					T436A9901		
3" ASA 150					T461A9901		
3" TTMA					T467A9901		
4" TTMA					T468A9901		

According to
NATO STANAG 3756

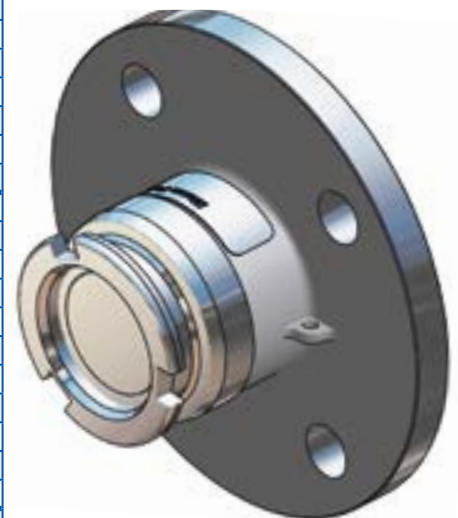

*) shortened version for tight installation situations

**) Type E (with spigot), EN 1092-1, see page 44

***) Flange with standard thickness

^{1A)} F = Female thread, BSP = EN ISO 228, NPT = ANSI B1.20.1

^{1B)} PN 10/16/25/40 = EN 1092 (types see page 44), ASA = ANSI B16.5 (150 o. 300 psi), DIN 28459 = old standard TW, 10 bar. TTMA = Truck Trailer Manufacturers Association

²⁾ Material: Al = Aluminium, GM = Gunmetal, SS = Stainless Steel

³⁾ Standard seal FPM/FKM. Alternative materials, e.g. EPDM, Chemraz®, Kalrez®, NBR or HNBR on request

Viton® is a registered trademark of DuPont, DuPont Elastomers.

3" (Ø 119 mm) Dropped Tank Unit (Adapter) with Flange Connection

Flange ¹⁾	Body Material ²⁾	Seal ³⁾	Weight ≈		Mann Tek Code No.
		O-Ring	kg	lbs	
DIN 28459 'TW 1' / DN 80	Al	Standard: FPM/FKM (Viton®)	1,6	3.5	T465I1101
DIN 28459 'TW 3' / DN 100			1,6	3.5	T466I1101
3" TTMA		Other on request.			T467I1101
4" TTMA					T468I1101

According to
NATO STANAG 3756

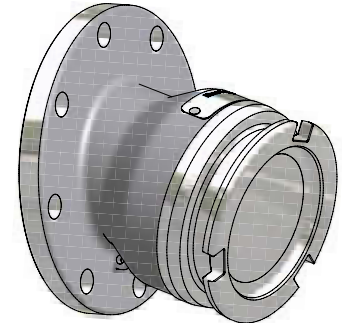

15° dropped Tank unit with flange connection makes it easier to connect when installed in high position and reduces hose wear.

¹⁾ DIN 28459 = old standard TW, 10 bar. TTMA = Truck Trailer Manufacturers Association

²⁾ Material: Al = Aluminium

³⁾ Standard seal FPM/FKM. Alternative materials, e.g. EPDM, Chemraz®, Kalrez®, NBR or HNBR on request

Viton® is a registered trademark of DuPont, DuPont Elastomers.

3" (Ø 119 mm) Tank Unit (Adapter) with Square Flange Connection

Flange ¹⁾	Body Material ²⁾	Seal ³⁾	Weight ≈		Mann Tek Code No.
		O-Ring	kg	lbs	
Normec (120x120 mm)	Al	Standard: FPM/FKM (Viton®)			T4107D1101
Normec (120x120 mm)	GM				T4107D2201

According to
NATO STANAG 3756



¹⁾ Normec = with drilling for Italian road tanker connection

²⁾ Material: Al = Aluminium, GM = Gunmetal

³⁾ Standard seal FPM/FKM. Alternative materials, e.g. EPDM, Chemraz®, Kalrez®, NBR or HNBR on request

Viton® is a registered trademark of DuPont, DuPont Elastomers.

3" (Ø 119 mm) Hose Unit (Coupler) – Female Thread

Connection ¹⁾ Inch/DN	Body Material ²⁾	Seal ³⁾		Weight ≈		Mann Tek Code No.
		O-Ring	Thread Seal	kg	lbs	
F 3" BSP	Al	Standard: FPM/FKM (Viton®)	PUR	3,8	8.4	S414B1101B
F 3" NPT			—	3,9	8.6	S415B1101
F 3" BSP	GM		PUR	8,4	18.5	S414B2201B
F 3" NPT			—	9,0	19.8	S415B2201
F 3" BSP	SS		PTFE	8,4	18.5	S414B4401A
F 3" NPT			—	8,7	19.2	S415B4401
F 3" BSP	Hastelloy		PTFE			S414A7701B
F 3" NPT			Other on request.	—	8,1	17.7
F 3" BSP	PVDF/Hastelloy		PTFE			S414A8701B
F 3" BSP	PEEK		PTFE			S414A9901B
F 3" NPT		—			S415A9901	

According to
NATO STANAG 3756



¹⁾ F = Female thread, BSP = EN ISO 228, NPT = ANSI B1.20.1

²⁾ Material: Al = Aluminium, GM = Gunmetal, SS = Stainless Steel

³⁾ Standard seal FPM/FKM. Alternative materials, e.g. EPDM, Chemraz®, Kalrez®, NBR or HNBR on request

3" (Ø 119 mm) Coupler – Flanged Inlet

Flange ¹⁾	Body Material ²⁾	Seal ³⁾		Weight ≈		Mann Tek Code No.
		O-Ring		kg	lbs	
undrilled Ø 210 mm	Al	Standard: FPM/FKM (Viton®)				S420B1101
DN 80 PN 10 / 16 Type A						S436B1101
3" ASA 150			5,5	12.1	S461B1101	
DIN 28459 'TW 1' / DN 80					S465B1101	
DIN 28459 'TW 3' / DN 100					S466B1101	
3" TTMA					S467B1101	
4" TTMA			5,5	12.1	S468B1101	
undrilled Ø 210 mm	GM					S320B2201
DN 80 PN 10/16 Type B					S436B2201	
DN 80 PN 25/40 Type B					S437B2201	
3" ASA 150					S461B2201	
3" ASA 300					S462B2201	
DIN 28459 'TW 1' / DN 80					S465B2201	
DIN 28459 'TW 3' / DN 100					S466B2201	
3" TTMA			S467B2201			
4" TTMA			S468B2201			
undrilled Ø 210 mm	SS	Other on request.			S420B4401	
o. Bohrungen Ø 210 mm**)				S420B4401F		
DN 80 PN 10/ 6 Type B		12,7	28.0	S436B4401		
DN 80 PN 10/16 Type B**)				S436B4401F		
DN 80 PN 25/40 Type B				S437B4401		
DN 80 PN 25/40 Type B**)				S437B4401F		
DN 80 PN 25/40 Type E				S435B4401F		
3" ASA 150		13,2	29.1	S461B4401		
3" ASA 150**)		13,2	29.1	S461B4401F		
3" ASA 300				S462B4401		
3" ASA 300**)		14,6	32.2	S462B4401F		
DIN 28459 'TW 1' / DN 80				S465B4401		
DIN 28459 'TW 3' / DN 100				S466B4401		
3" TTMA				S467B4401		
4" TTMA			S468B4401			
undrilled Ø 210 mm	PEEK				S420B9901	
DN 80 PN 10/16 Type B				S436B9901		
3" ASA 150				S461B9901		

According to
NATO STANAG 3756



^{*)} Type E (with spigot),
EN 1092-1, see page 44

^{**)} Flange with standard thickness

¹⁾ PN 10/16/25/40 = EN 1092
(types see page 44),
ASA = ANSI B16.5 (150 o. 300 psi),
DIN 28459 = old standard TW, 10 bar.
TTMA = Truck Trailer Manufacturers Association

²⁾ Material: Al = Aluminium, GM = Gunmetal,
SS = Stainless Steel

³⁾ Standard seal FPM/FKM. Alternative
materials, e.g. EPDM, Chemraz®, Kalrez®,
NBR or HNBR on request

Viton® and Teflon® are registered
trademarks of DuPont, DuPont Elastomers.

4" (Ø 164 mm) Technical Information

Tank Unit (Adapter) and Hose Unit (Coupler)



According to NATO STANAG 3756

Material	Maximum Working Pressure	Test Pressure	Minimum Burst Pressure
Aluminium	10 bar / 145 psi	15 bar / 218 psi	50 bar / 726 psi
Brass/Gunmetal	16 bar / 232 psi	24 bar / 348 psi	80 bar / 1160 psi
Stainless Steel	25 bar / 363 psi	37,5 bar / 544 psi	125 bar / 1813 psi

Connections

4" in BSP, NPT and flanged inlet.

Applications

Recommended for HiFlo-loading/unloading of rail tankers, aviation refuellers and road tankers. Also suitable for ship to shore transfer, ship to ship transfer and ship to rig transfer or on any application where spillage needs to be minimized.

Media

Petroleum products: gasoline, diesel, oil etc.

Chemical products: ethylene oxide, propylene oxide, acrylonitrile, butadiene, ammonia, vinyl chloride, toluene, xylene, sulphuric acid, phenol etc.

Gas: vapor recovery/balance systems for various media.

Dry powder

Material of Body

Aluminium, brass/gunmetal, stainless steel, Hastelloy and PEEK. Other materials on request.

Seals

StandardSeals FPM (Viton®), EPDM, FFKM (Chemraz®, Kalrez®), NBR. Other on request.

High Flow Rates / Low Pressure Drop

Allows maximum product transfer with minimal losses

Recommended Maximum Flow Rates

3500 litres/minute (fuel)

Selectivity

- avoid mixing products

To avoid product contamination caused by connecting a hose unit to the wrong tank unit, selective versions of the hose and tank units are available.

Each unit has a number of selective positions, designated by a coded part number according to the coupling size – specify when placing order. See page 32 ff.

Interchangeability

Compatible with couplings of other manufacturers.

Hose Unit with Integrated Swivel

All hose units are supplied with an integrated swivel.

4" (Ø 164 mm) Tank Unit (Adapter) – Female Thread

Connection ¹⁾ Inch/DN	Body Material ²⁾	Seal ³⁾		Weight ≈		Mann Tek Code No.	
		O-Ring	Thread Seal	kg	lbs		
F 4" BSP	Al	Standard: FPM/FKM (Viton®)	PUR	2,5	5,5	T516A1101B	
F 4" NPT			—	2,8	6,2	T517A1101	
F 4" BSP	GM		PUR	7,0	15,4	T516D2201B	
F 4" NPT			—	7,7	17,0	T517D2201	
F 4" BSP	SS		Other on request.	PTFE	6,0	13,2	T516B4401A
F 4" NPT			—	6,4	14,1	T517B4401	

According to
NATO STANAG 3756



¹⁾ F = Female thread, BSP = EN ISO 228, NPT = ANSI B1.20.1

²⁾ Material: Al = Aluminium, GM = Gunmetal, SS = Stainless Steel

³⁾ Standard seal FPM/FKM. Alternative materials, e.g. EPDM, Chemraz®, Kalrez®, NBR or HNBR on request

Viton® is a registered trademark of DuPont, DuPont Elastomers.

4" (Ø 164 mm) Tank Unit (Adapter)– Flanged Inlet

Flange ¹⁾	Body Material ²⁾	Seal ³⁾		Weight ≈		Mann Tek Code No.	
		O-Ring		kg	lbs		
undrilled Ø 230 mm	Al	Standard: FPM/FKM (Viton®)	Other on request.	3,2	7,1	T521D1101	
DN 100 PN 10/16 Type B				3,1	6,8	T539D1101	
4" ASA 150				3,2	7,1	T563D1101	
DIN 28459 'TW 3' / DN 100				2,6	5,7	T566D1101	
4" TTMA				2,6	5,7	T568D1101	
undrilled Ø 230 mm	GM			T521D2201			
DN 100 PN 10/16 Type B				T539D2201			
DN 100 PN 25/40 Type B				T540D2201			
4" ASA 150				T563D2201			
4" ASA 300 psi				T564D2201			
DIN 28459 'TW 3' / DN 100	T566D2201						
4" TTMA	T568D2201						
undrilled Ø 230 mm	SS			T521B4401			
o. Bohrungen Ø 230 mm ^{**)}				T521B4401F			
DN 100 PN 10/16 Type B				8,7	19,2	T539B4401	
DN 100 PN 10/16 Type B ^{**)}		8,6	19,0	T539B4401F			
DN 100 PN 25/40 Type B				T540B4401			
DN 100 PN 25/40 Type B ^{**)}				T540B4401F			
DN 100 PN 25/40 Type E				T538B4401F			
4" ASA 150		8,9	19,6	T563B4401			
4" ASA 150 ^{**)}		8,9	19,6	T563B4401F			
4" ASA 300 psi		12	26,5	T564B4401			
4" ASA 300 psi ^{**)}		12	26,5	T564B4401F			
DIN 28459 'TW 3' / DN 100				T566B4401			
4" TTMA		2,5	5,5	T568B4401			

According to
NATO STANAG 3756



^{*}) Type E (with spigot),
EN 1092-1, see page 44

^{**)} Flange with standard thickness

¹⁾ PN 10/16/25/40 = EN 1092
(types see page 44),
ASA = ANSI B16.5 (150 o. 300 psi),
DIN 28459 = old standard TW, 10 bar.
TTMA = Truck Trailer Manufacturers Association

²⁾ Material: Al = Aluminium, GM = Gunmetal,
SS = Stainless Steel

³⁾ Standard seal FPM/FKM. Alternative
materials, e.g. EPDM, Chemraz®, Kalrez®,
NBR or HNBR on request

Viton® is a registered trademark of DuPont,
DuPont Elastomers.

4" (Ø 164 mm) Hose Unit (Coupler) – Female Thread

Connection ¹⁾ Inch/DN	Body Material ²⁾	Seal ³⁾		Weight ≈		Mann Tek Code No.	
		O-Ring	Thread Seal	kg	lbs		
F 4 BSP	Al	Standard: FPM/FKM (Viton®)	PUR (Polyurethane)	7,6	16,8	S516B1101B	
F 4" ASSPT						S5136B1101B	
F 4" NPT						S517B1101	
F 4" BSP	GM		PUR (Polyurethane)	17,5	38,6	S516B2201B	
F 4" ASSPT						S5136B2201B	
F 4" NPT						S517B2201	
F 4" BSP	SS		Other on request.	PTFE	15,6	34,4	S516B4401A
F 4" ASSPT							S5136B4401A
F 4" NPT							S517B4401

According to
NATO STANAG 3756



¹⁾ F = Female thread, BSP = EN ISO 228, NPT = ANSI B1.20.3,

ASSPT = American Straight Pipe Thread, identical to NPS. NPT male threads can be connected with ASSPT female threads.

²⁾ Material: Al = Aluminium, GM = Gunmetal, SS = Stainless Steel

³⁾ Standard seal FPM/FKM. Alternative materials, e.g. EPDM, Chemraz®, Kalrez®, NBR or HNBR on request

4" (Ø 164 mm) Coupler – Flanged Inlet

Flange ¹⁾	Body Material ²⁾	Seal ³⁾		Weight ≈		Mann Tek Code No.				
		O-Ring		kg	lbs					
undrilled Ø 230 mm	Al	Standard: FPM/FKM (Viton®)	Other on request.			S521B1101				
DN 100 PN 10/16 Type B				9,3	20,0	S539B1101				
4" ASA 150				9,4	20,7	S563B1101				
4" TTMA				8,7	19,2	S568B1101				
DIN 28459 'TW 3' / DN 100				8,7	19,2	S566B1101				
undrilled Ø 230 mm	Br			Other on request.				S521B2201		
DN 100 PN 10/16 Type B								S539B2201		
DN 100 PN 25/40 Type B						23,9	52,7	S540B2201		
4" ASA 150						23,9	52,7	S563B2201		
4" ASA 300 psi								S564B2201		
4" TTMA							S568B2201			
DIN 28459 'TW 3' / DN 100							S566B2201			
undrilled Ø 230 mm	SS					Other on request.		16,1	35,5	S521B4401
o. Bohrungen Ø 230 mm ^{**)}										S521B4401F
DN 100 PN 10/16 Type B								16,1	35,5	S539B4401
DN 100 PN 10/16 Type B ^{**)}		16,1	35,5					S539B4401F		
DN 100 PN 25/40 Type B		16,1	35,5					S540B4401		
DN 100 PN 25/40 Type B ^{**)}								S540B4401F		
DN 100 PN 25/40 Type E								S538B4401F		
4" ASA 150		21,0	46,3					S563B4401		
4" ASA 150 ^{**)}		21,0	46,3	S563B4401						
4" ASA 300 psi		16,1	35,5	S564B4401						
4" ASA 300 psi ^{**)}				S564B4401F						
4" TTMA		8,7	19,2	S568B4401						
DIN 28459 'TW 3' / DN 100				S566B4401						

According to
NATO STANAG 3756



^{*}) Type E (with spigot),
EN 1092-1, see page 44

^{**)} Flange with standard thickness

¹⁾ PN 10/16/25/40 = EN 1092
(types see page 44),
ASA = ANSI B16.5 (150 o. 300 psi),
DIN 28459 = old standard TW, 10 bar.
TTMA = Truck Trailer Manufacturers
Association

²⁾ Material: Al = Aluminium,
GM = Gunmetal, SS = Stainless Steel

³⁾ Standard seal FPM/FKM. Alternative
materials, e.g. EPDM, Chemraz®,
Kalrez®, NBR or HNBR on request

Viton® is a registered trademark of
DuPont, DuPont Elastomers.

6" (Ø 238 mm) Technical Information

Tank Unit (Adapter) and Hose Unit (Coupler)



Material	Maximum Working Pressure	Test Pressure	Minimum Burst Pressure
Aluminium	10 bar / 145 psi	15 bar / 218 psi	50 bar / 726 psi
Stainless Steel	16 bar / 232 psi	24 bar / 348 psi	80 bar / 1160 psi

Connections

6" in BSP, NPT and flanged inlet.

Applications

Recommended for marine bunkering, ship to shore transfer, ship to ship transfer and ship to rig transfer or on any application where spillage needs to be minimized.

Media

Petroleum products: gasoline, diesel, oil etc.

Chemical products: ethylene oxide, propylene oxide, acrylonitrile, butadiene, ammonia, vinyl chloride, toluene, xylene, sulphuric acid, phenol etc.

Dry powder

Material of Body

Aluminium or stainless steel; other materials on request.

Seals

Standard seals FPM (Viton®), EPDM, FFKM (Chemraz®, Kalrez®), NBR. Other on request.

High Flow Rates / Low Pressure Drop

Allows maximum product transfer with minimal losses

Recommended Maximum Flow Rates

4000 litres/minute (fuel)

Selectivity

- avoid mixing products

To avoid product contamination caused by connecting a hose unit to the wrong tank unit, selective versions of the hose and tank units are available.

Each unit has a number of selective positions, designated by a coded part number according to the coupling size – specify when placing order. See page 32 ff.

Interchangeability

Compatible with couplings of other manufacturers.

Hose Unit with Integrated Swivel

All hose units are supplied with an integrated swivel.

6" (Ø 238 mm) Tank Unit (Adapter) – Female Thread

Connection ¹⁾ Inch/DN	Body Material ²⁾	Seal		Weight ≈		Mann Tek Code No.
		O-Ring ³⁾	Thread Seal	kg	lbs	
F 6" BSP	Al	Standard: FPM/FKM (Viton®) Other on request.	PUR	6,7	14.8	T6110B1101B
F 6" NPT			—	7,1	15.7	T6111B1101
F 6" BSP	SS		PTFE	15,7	34.6	T6110B4401A
F 6" NPT			—	17,6	38.8	T6111B4401



6" (Ø 238 mm) Tank Unit (Adapter) – Flanged Inlet

Flange ^{1B)}	Body Material ²⁾	Seal ³⁾	Weight ≈		Mann Tek Code No.
		O-Ring	kg	lbs	
DN 150 PN 10/16 Type A	Al	Standard: FPM/FKM (Viton®) Other on request.	8,6	19.0	T645B1101
6" ASA 150			7,5	16.5	T6100B1101
DN 150 PN 10/16 Type B	SS		22,4	49.4	T645B4401
6" ASA 150			22,4	49.4	T6100B4401



6" (Ø 238 mm) Hose Unit (Coupler) – Female Thread

Connection ¹⁾ Inch/DN	Body Material ²⁾	Seal		Weight ≈		Mann Tek Code No.
		O-Ring ³⁾	Thread Seal	kg	lbs	
F 6" BSP	Al	Standard: FPM/FKM (Viton®) Other on request.	PUR	22,3	49.2	S6110B1101B
F 6" NPT			—			S6111B1101
F 6" BSP	SS		PTFE			S6110B4401A
F 6" NPT			—	45,0	99.2	S6111B4401



6" (Ø 238 mm) Coupler – Flanged Inlet

Flange ^{1B)}	Body Material ²⁾	Seal ³⁾	Weight ≈		Mann Tek Code No.
		O-Ring	kg	lbs	
DN 150 PN 10/16 Type A	Al	Standard: FPM/FKM (Viton®) Other on request.			S645B1101
6" ASA 150			25,9	57.1	S6100B1101
DN 150 PN 10/16 Type B	SS				S645B4401
6" ASA 150			49,5	109.1	S6100B4401



^{1A)} F = Female thread, BSP = EN ISO 228, NPT = ANSI B1.20.1

^{1B)} PN 10/16/25/40 = EN 1092 (types see page 44), ASA 150 = ANSI B16.5, 150 psi

²⁾ Material: Al = Aluminium, SS = Stainless Steel

³⁾ Standard seal FPM/FKM. Alternative materials, e.g. EPDM, Chemraz®, Kalrez®, NBR or HNBR on request

Viton® is registered trademark of DuPont, DuPont Elastomers.

8" (Ø 272 mm) Technical Information

Tank Unit (Adapter) and Hose Unit (Coupler)



Material	Maximum Working Pressure	Test Pressure	Minimum Burst Pressure
Aluminium	10 bar / 145 psi	15 bar / 218 psi	50 bar / 726 psi
Stainless Steel	16 bar / 232 psi	24 bar / 348 psi	80 bar / 1160 psi

Connections

8" flanged inlet (or NPT thread)

Applications

Recommended for marine bunkering, ship to shore transfer, ship to ship transfer and ship to rig transfer or on any application where spillage needs to be minimized.

Media

Petroleum products: gasoline, diesel, oil etc.

Chemical products: ethylene oxide, propylene oxide, acrylonitrile, butadiene, ammonia, vinyl chloride, toluene, xylene, sulphuric acid, phenol etc.

Dry powder

Material of Body

Aluminium, brass/gunmetal, stainless steel, Hastelloy and PEEK. Other materials on request.

Seals

Standard seals FPM (Viton®), EPDM, FFKM (Chemraz®, Kalrez®), NBR. Other on request.

High Flow Rates / Low Pressure Drop

Allows maximum product transfer with minimal losses

Recommended Maximum Flow Rates

7500 litres/minute (fuel)

Selectivity

- avoid mixing products

To avoid product contamination caused by connecting a hose unit to the wrong tank unit, selective versions of the hose and tank units are available.

Each unit has a number of selective positions, designated by a coded part number according to the coupling size – specify when placing order. See page 32 ff.

Interchangeability

Compatible with couplings of other manufacturers.

Hose Unit with Integrated Swivel

All hose units are supplied with an integrated swivel.

8" (Ø 272 mm) Tank Unit (Adapter) – Flanged Inlet

Flange ¹⁾	Body Material ²⁾	Seal ³⁾	Weight ≈		Mann Tek Code No.	
		O-Ring	kg	lbs		
DN 200 PN 10 Type A	AI	Standard: FPM/FKM (Viton®)			T8102A1101	
DN 200 PN 16 Type A					T8103A1101	
8" ASA 150					T8105A1101	
DN 200 PN 10 Type B	SS		Other on request.			T8102A4401
DN 200 PN 16 Type B						T8103A4401
8" ASA 150				39,0	86.0	T8105A4401

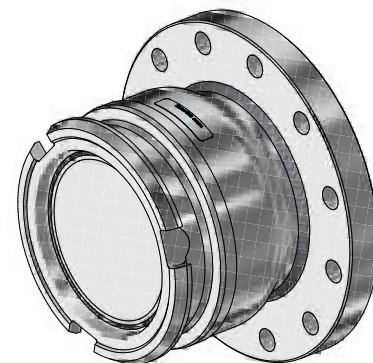

*) alternatively also available with NPT female inlet

8" (Ø 272 mm) Coupler – Flanged Inlet

Flange ¹⁾	Body Material ²⁾	Seal ³⁾	Weight ≈		Mann Tek Code No.	
		O-Ring	kg	lbs		
DN 200 PN 10 Type A	AI	Standard: FPM/FKM (Viton®)			S8102A1101	
DN 200 PN 16 Type A					S8103A1101	
8" ASA 150			93,0	205.0	S8105A1101	
DN 200 PN 10 Type B	SS		Other on request.			S8102A4401
DN 200 PN 16 Type B						S8103A4401
8" ASA 150				93,0	205.0	S8105A4401



*) alternatively also available with NPT female inlet

¹⁾ PN 10/16/25/40 = EN 1092 (types see page 44), ASA = ANSI B16.5 (150 psi)

²⁾ Material: AI = Aluminium, SS = Stainless Steel

³⁾ Standard seal FPM/FKM. Alternative materials, e.g. EPDM, Chemraz®, Kalrez®, NBR or HNBR on request

Viton® is a registered trademark of DuPont, DuPont Elastomers.

Dust Cap for Tank Unit (Adapter)

To increase the lifespan of DDC tank units, dust caps should be used. They protect the couplings against the ingress of dirt and water.

Materials: polyethylene, aluminum, stainless steel or rubber.
Supplied with cable attachment and eyelets (rubber design DN 40 - 50 with integrated eyelet).

With the exception of the simple rubber type, the caps feature a safeguard against inadvertent release: before removing the cap, a spring-loaded locking pin is pulled.

Polyethylene composite caps in sizes DN 40-80 mm include a patented design with lip seal to facilitate the handling.

PE-Composite
Patent No. 000840780-0001



Stainless Steel



Rubber



Inch / DN	Material ¹⁾	Seal ²⁾	Weight ≈		Mann Tek Code No.
			kg	lbs	
¾"-1" Ø 56 mm, DN 20-25	PE	Standard: FPM (Viton®)	0,1	0.29	C100A2201
	AI		0,2	0.49	C100A1101
	SS		0,6	1.30	C100A4401
1½"-2" Ø 70 mm, DN 40-50	PE	NBR	0,1	0.2	C200E2202
	AI	Standard: FPM (Viton®)	0,3	0.7	C200A1101
	SS		0,6	1.3	C200C4401
	Rubber		0,1	0.3	C200D1300
2½" Ø 105 mm, DN 65	PE	NBR	0,2	0.4	C300E2202
	AI	Standard: FPM (Viton®)			C300A1101
	SS		1,5	3,3	C300C4401
3" Ø 119 mm, DN 80	PE	NBR	0,2	0.5	C400E2202
	AI	Standard: FPM (Viton®)			C400A1101
	SS				C400C4401
	Rubber	—			C400D1300
4" Ø 164 mm, DN 100	PE	Standard: FPM (Viton®)	0,2	0.5	C500E2202
	AI		1,2	2,5	C500B1101
	SS		2,5	5,5	C500C4401
6" Ø 238 mm, DN 150	PE	Standard: FPM (Viton®)			C600A2201
	AI		1,6	3,4	C600A1101
	SS				C600A4401
8" Ø 272 mm, DN 200	AI	Standard: FPM (Viton®)			C800B1101
	SS				C800B4401



Rubber



¹⁾ Material: PE = Polyethylen-Composite, AI = Aluminium, SS = Stainless Steel, Rubber = NBR/PVC

²⁾ Standard seal FPM/FKM or NBR. Alternative materials, e.g. EPDM, Chemraz®, Kalrez® or HNBR on request

Viton® is a registered trademark of DuPont, DuPont Elastomers.

Pressure Cap for Tank Unit (Adapter)

used as third closing device according to ADR/RID, par. 6.8.2.2.2

Mann Tek pressure caps have been developed to increase the safety of the operating personnel and improve leak protection.

In case of an upstream leakage (male coupling untight) or extensive pressure buildup within the tank outlet due to expanding gas, the cap will indicate it. The operator relieves the pressure by pressing the lever and can then safely remove the cap.

Features

- Corresponds to ADR/RID regulations
- 'Third closing device' for road and rail tankers, containers
- Working pressure up to 25 bar
- Excess pressure indicator
- Safe relief for pressure and vacuum
- Customs /tamper sealing possible (holes for sealing wire)
- Automatic locking
- Anti-theft protection: locking with standard padlock possible

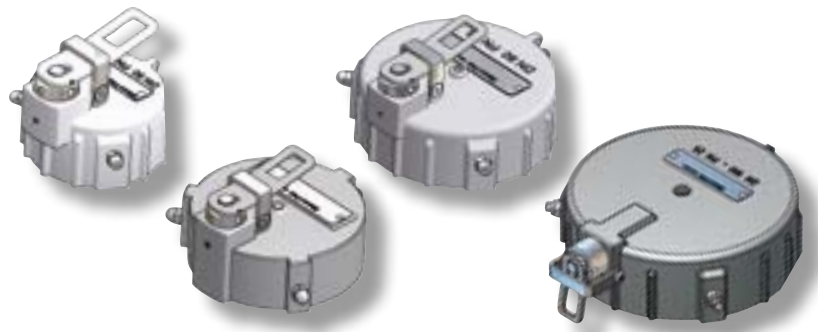

How It Works :



Pressure Indicator
(warns for overpressure)

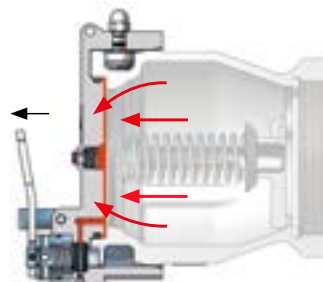

Press the handle for pressure relief, opening

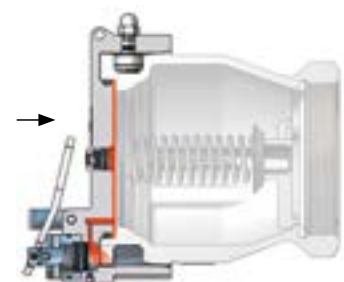

Inch / DN	Material of Body ¹⁾	Seal ²⁾	Working Pressure	Mann Tek Code No.
1½ - 2" Ø 70 mm, DN 40-50	SS	Standard: FPM (Viton®) Other on request.	25 bar / 363 psi	R200A4401
2½" Ø 105 mm, DN 65	SS		25 bar / 363 psi	R300A4401
3" Ø 119 mm, DN 80	SS		25 bar / 363 psi	R400A4401
4" Ø 164 mm, DN 100	Al		10 bar / 145 psi	R500B1101
	SS	25 bar / 363 psi	R500B4401	

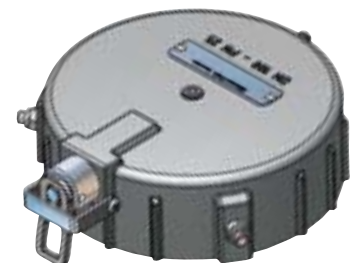

¹⁾ Material: Al = Aluminium, SS = Stainless Steel

²⁾ Standard seal FPM/FKM or NBR. Alternative materials, e.g. EPDM, Chemraz® or Kalrez® on request

Viton® is a registered trademark of DuPont, DuPont Elastomers.

Sealing Cap for Tank Unit (Adapter) – 10 bar / 150psi

Suitable if a pressure tightness up to 10 bar - but no pressure relief - is required.
Supplied with cable and mounting eyelets.

Inch / DN	Material of Body ¹⁾	Seal ²⁾	Weight ≈		Mann Tek Code No.
			kg	lbs	
¾"-1" Ø 56 mm, DN 20-25	SS	Standard: FPM (Viton®) Other on request.	0,6	1,30	C100P4401
	Al		0,3	0,7	C200P1101
1½"-2" Ø 70 mm, DN 40-50	SS		0,4	0,9	C200P4401
	SS		1,5	1,1	C300P4401
2½" Ø 105 mm, DN 65	Al		0,6	1,3	C400H1101
	SS		1,3	2,9	C400P4401
3" Ø 119 mm, DN 80	Al		2,9	6,4	C500P4401
	SS				
4" Ø 164 mm, DN 100	Al				
	SS				

¹⁾ Material: Al = Aluminium, SS = Stainless Steel

²⁾ Standard seal FPM/FKM or NBR. Alternative materials, e.g. EPDM, Chemraz® or Kalrez® on request



Dust plug for Hose Unit (Coupler)

To increase the lifespan of couplers, dust plugs should be used. They protect the couplings against the ingress of dirt and water. Materials: polyethylene, aluminum, stainless steel. Supplied with cable attachment and eyelets.

Inch / DN	Material of Body ¹⁾	Seal ²⁾	Weight ≈		Mann Tek Code No.
			kg	lbs	
¾"-1" Ø 56 mm, DN 20-25	PE	Standard: FPM (Viton®) Other on request.	0,1	0,1	P100A2201
	Al		0,1	0,3	P100A1101
	SS		0,3	0,7	P100A4401
1½"-2" Ø 70 mm, DN 40-50	PE		0,1	0,2	P200A2201
	Al		0,2	0,5	P200A1101
	SS		0,2	0,6	P200A4401
2½" Ø 105 mm, DN 65	PE		0,2	0,5	P300A2201
	Al		0,6	1,2	P300A1101
	SS				P300A4401
3" Ø 119 mm, DN 80	PE		0,1	0,2	P400A2201
	Al	0,7	1,6	P400A1101	
	SS	0,6	1,3	P400A4401	
4" Ø 164 mm, DN 100	PE	0,2	0,4	P500B2201	
	Al	0,3	0,7	P500B1101	
	SS			P500A4401	
6" Ø 238 mm, DN 150	PE			P600A2201	
	Al	1,2	0,4	P600A1101	
	SS			P600A4401	
8" Ø 272 mm, DN 200	Al	1,2	0,4	P800A1101	
	SS			P800A4401	

¹⁾ Material: PE = Polyethylene Composite, Al = Aluminium, SS = Stainless Steel

²⁾ Standard seal FPM/FKM or NBR. Alternative materials, e.g. EPDM, Chemraz®, Kalrez® or HNBR on request

Viton® is a registered trademark of DuPont, DuPont Elastomers.



Parking Adapter or Hose Unit (Coupler)

Coupling size	Material	Mann Tek Code-Nr.
1" (Ø 56 mm)	Al	Tool 104-1
		Tool 104-1-M18*)
	SS	Tool 104-4
		Tool 104-4-M18*)
2" (Ø 70 mm)	Al	Tool 204-1
		Tool 204-1-M18*)
	SS	Tool 204-4
		Tool 204-4-M18*)
2½" (Ø 105 mm)	Al	Tool 304-1
		Tool 304-1-M18*)
	SS	Tool 304-4
		Tool 304-4-M18*)
3" (Ø 119 mm)	Al	Tool 404-1
		Tool 404-1-M18*)
	SS	Tool 404-4
		Tool 404-4-M18*)
4" (Ø 164 mm)	Al	Tool 504-1
		Tool 504-1-M18*)
	SS	Tool 504-4
		Tool 504-4-M18*)
6" (Ø 238 mm)	Al	Tool 604-1
		Tool 604-1-M18*)
	SS	Tool 604-4
		Tool 604-4-M18*)

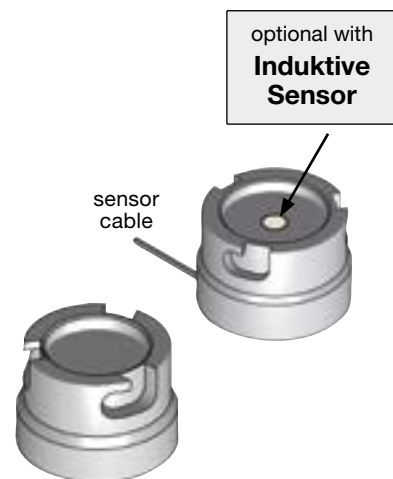

Parking adapters serve as a support for couplers when not in use.

They are screwed to the wall or other objects.

*) With Inductive sensor

Material: Al = Aluminium, SS = Stainless steel

Selectivity System: Overview

To prevent accidental mixing of media, a selectivity system for DDCouplings is available. Tank units are equipped with slots, hose units with pins.

Depending on the size of the coupling and required compatibility, the number of possible 'selectivity positions' varies.

In case of questions please consult our sales team.

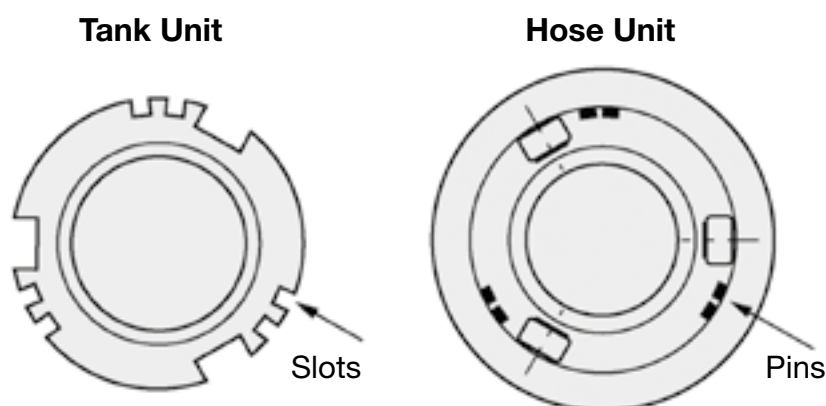

Product	Size	Position
Avgas 100 / 130	2½", 3", 4"	1
Avgas 108 / 135	2½", 3", 4"	2
Avgas 115 / 145	2½", 3", 4"	3
Avtur (Derd 2495) JP1, ATK, ATF 650. JET 'A'	2½", 3", 4"	4
Avtag (Derd 2486) JP4, ATG, JET 'B'	2½", 3", 4"	5

Example: Aircraft Refuelling

The major oil companies have agreed to use the following selectivity positions for aviation refuelling. For the 2½", 3" and 4" sizes.

Selectivity System for 1" (Ø 56 mm)

Coupling diameter:
Ø56 mm (¾"-1")

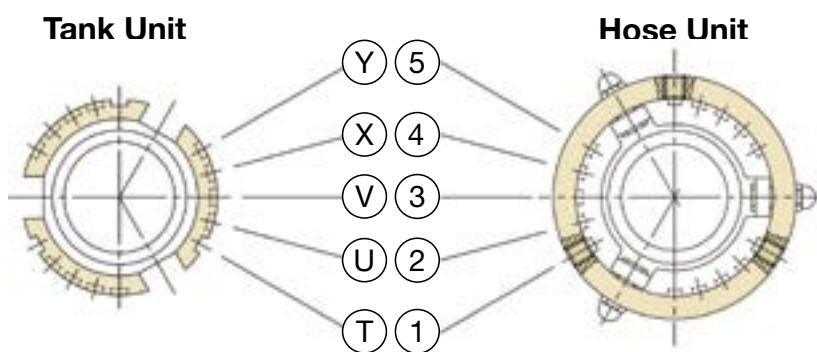

Selectivity system:

Mann Tek, Todo.

Each unit can be provided with selectivity according to two systems – with 5 or 10 positions (see chart).

When ordering, please add "/SEL" and the chosen selectivity to the Mann Tek Code No.

Examples: S103A4401/**SEL 1** (T) or S103A4401/**SEL 12** (TU)

Media	Position
acrylonitrile	4 (X)
ethylene oxide	2 (U)
Propylene eoxid	3 (V)

Selectivity positions for acrylonitrile, ethylene oxide and propylene oxide for 1"

With 5 Positions

T	U	V	X	Y
1	2	3	4	5

With 10 Positions

TU	TV	TX	TY	UV
12	13	14	15	23
24	25	34	35	45
UX	UY	VX	VY	XY

Selectivity System for 2" (Ø 70 mm)

Coupling diameter:
Ø 70 mm (1½"-2")

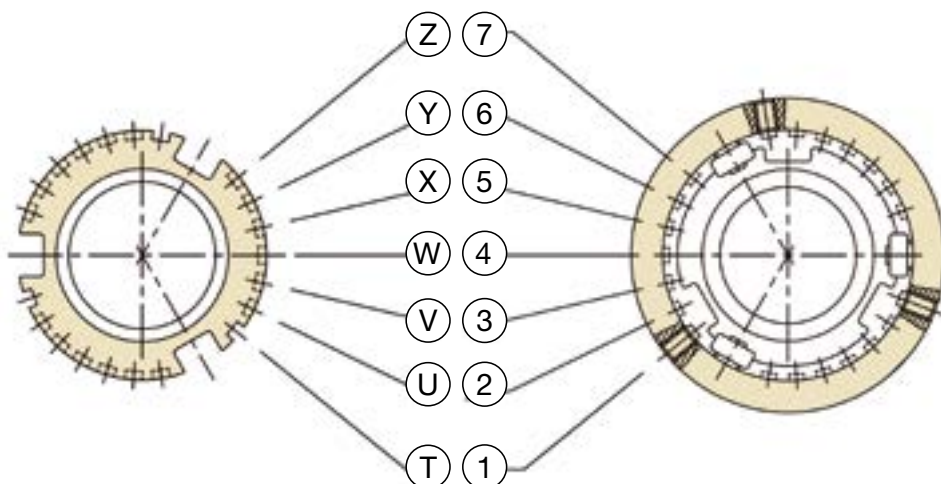

Media	Position
acrylonitrile	X (5)
ethylene oxide	V (3)
propylene oxide	W (4)

Selectivity positions for acrylonitrile, ethylene oxide and propylene oxide for 2"

With 7 Positions

T	U	V	W	X	Y	Z
1	2	3	4	5	6	7

Selectivity System:

Mann Tek, Todo, Avery Hardoll, NATO STANAG 3756.

Each unit can be provided with selectivity according to two systems – with 7 or 21 positions (see chart).

When ordering, please add "/SEL" and the chosen selectivity to the Mann Tek Code No.

Examples: S210A4401A/**SEL 1** (T)
or S210A4401A/**SEL 12** (TU)

With 21 Positions

TU	TV	TW	TX	TY	TZ	UV	UW	UX	UY	UZ
12	13	14	15	16	17	23	24	25	26	27
34	35	36	37	45	46	47	56	57	67	
VW	VX	VY	VZ	WX	WY	WZ	XY	XZ	YZ	

Selectivity System for 2" (Ø 70 mm) – Special Version Fort Vale™

Coupling diameter:
Ø 70 mm (1½"-2")

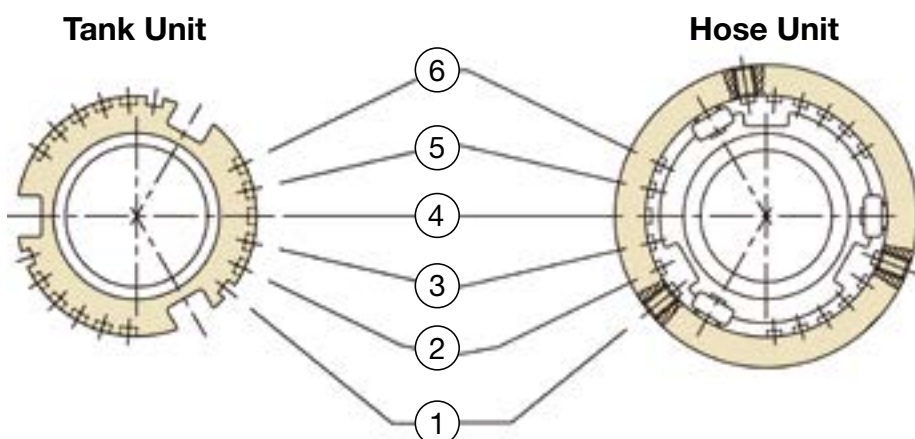

Selectivity System:

"Fort Vale"

Each unit can be provided with selectivity with 15 positions (see chart).

When ordering, please add the chosen selectivity to the Mann Tek Code No.

Example: S210A4401A/**FV-SEL 12**

With 15 Positions

A	B	C	D	E	F	G	H	J	K	L	M	N	P	Q
12	13	14	15	16	17	23	24	25	26	34	35	36	45	56

Selectivity System for 2½" (Ø 105 mm)

Coupling diameter:
Ø 105 mm (2½")

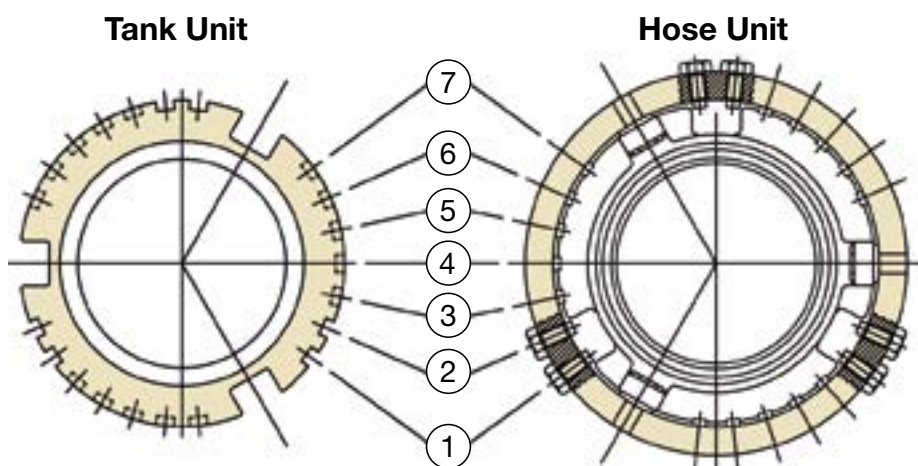

With 7 Positions

1	2	3	4	5	6	7
---	---	---	---	---	---	---

Selectivity System:

Mann Tek, Todo, NATO STANAG 3756,
Avery Hardoll

Each unit can be provided with selectivity according to two systems – with 7 or 21 positions (see chart).

When ordering, please add "/SEL" and the chosen selectivity to the Mann Tek Code No.

Examples: S312A4401/**SEL 1** or S312A4401/**SEL 12 (A)**

With 21 Positions

A	B	C	D	E	F	G	H	I	K	L
12	13	14	15	16	17	23	24	25	26	27
34	35	36	37	45	46	47	56	57	67	
M	N	P	Q	R	S	T	U	V	W	

Selectivity System for 2½" (Ø 105 mm) – Special Version Fulcrum

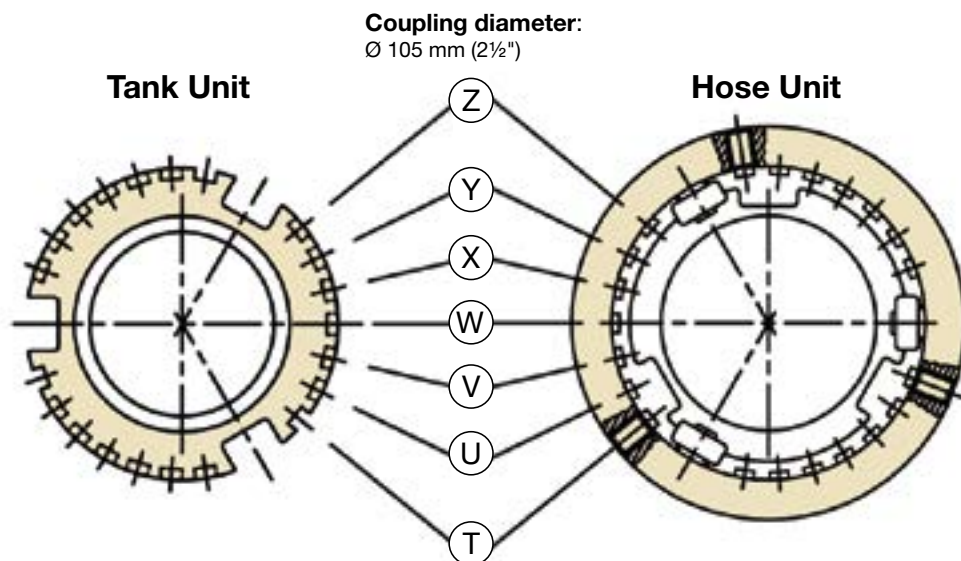

With 7 Positions

1	2	3	4	5	6	7
---	---	---	---	---	---	---

Selectivity System:

Fulcrum

Each unit can be provided with selectivity according to two systems – with 7 or 21 positions (see chart).

When ordering, please the chosen selectivity to the Mann Tek Code No.

Examples: S312A4401/**SEL 1** or S312A4401/**SEL 12 (A)**

With 21 Positions

TU	TV	TW	TX	TY	TZ	UV
UW	UX	UY	UZ	VW	VX	VY
VZ	WX	WY	WZ	XY	XZ	YZ

Selectivity System for 3" (Ø 119 mm)

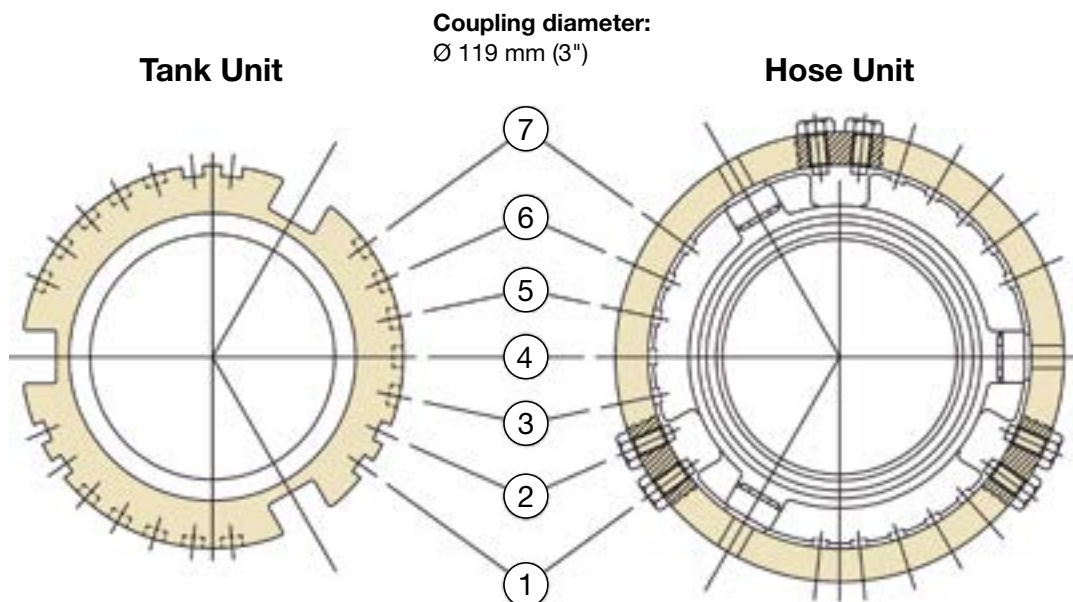

Media	Position
acrylonitrile	36 (P)
ethylene oxide	34 (M)
propylene oxide	35 (N)

Selectivity positions for acrylonitrile, ethylene oxide and propylene oxide for 3"

With 7 Positions

1	2	3	4	5	6	7
---	---	---	---	---	---	---

Selectivity System:

Mann Tek, Todo, NATO STANAG 3756, Avery Hardoll

Each unit can be provided with selectivity according to two systems – with 7 or 21 positions (see chart).

When ordering, please add "/SEL" and the chosen selectivity to the Mann Tek Code No.

Examples: S414A4401/**SEL 1** bzw. S414A4401/**SEL 12 (A)**

With 21 Positions

A	B	C	D	E	F	G	H	I	K	L
12	13	14	15	16	17	23	24	25	26	27
34	35	36	37	45	46	47	56	57	67	
M	N	P	Q	R	S	T	U	V	W	

Selectivity System for 4" (Ø 164 mm)

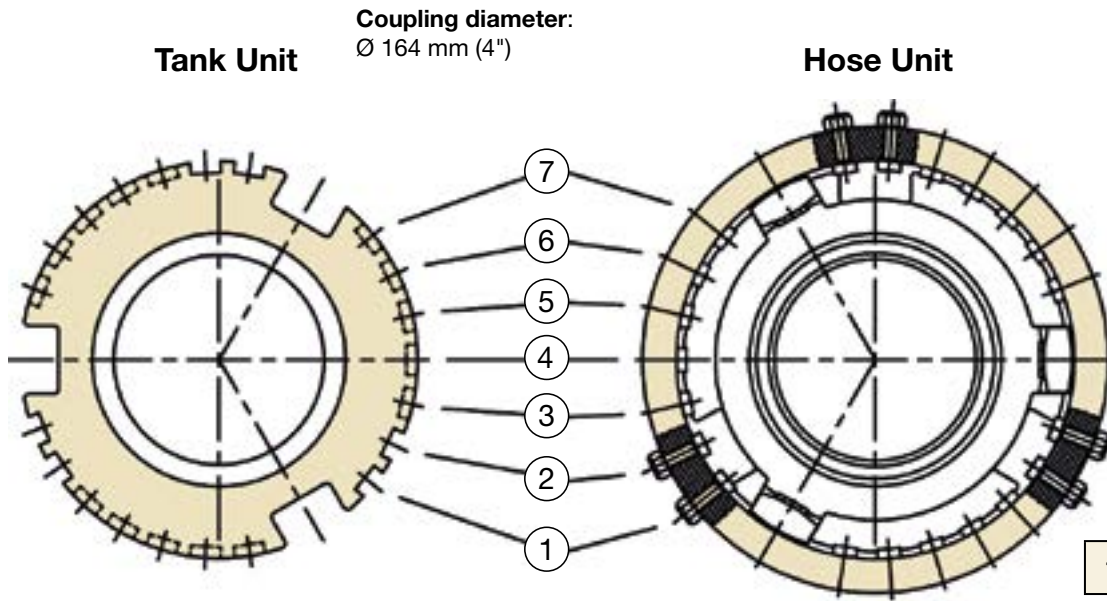

Media	Position
acrylonitrile	36 (P)
ethylene oxide	34 (M)
propylene oxide	35 (N)

Selectivity positions for acrylonitrile, ethylene oxide and propylene oxide for 4".

With 7 Positions

1	2	3	4	5	6	7
---	---	---	---	---	---	---

Selectivity System:

Mann Tek, Todo, NATO STANAG 3756, Avery Hardoll

Each unit can be provided with selectivity according to two systems – with 7 or 21 positions (see chart).

When ordering, please add "/SEL" and the chosen selectivity to the Mann Tek Code No.

Examples: S516A4401/**SEL 1** or S516A4401/**SEL 12 (A)**

With 21 Positions

A	B	C	D	E	F	G	H	I	K	L
12	13	14	15	16	17	23	24	25	26	27
34	35	36	37	45	46	47	56	57	67	
M	N	P	Q	R	S	T	U	V	W	

Selectivity System for 6" (Ø 238 mm)

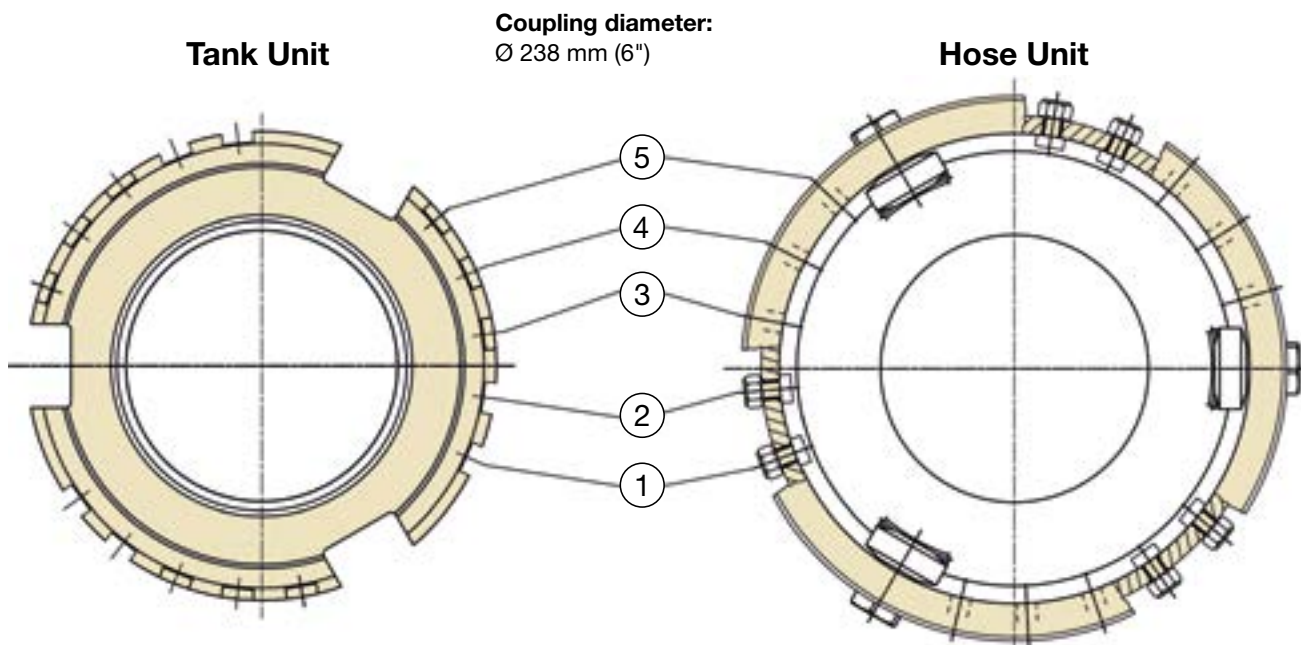

Selectivity System:

Compatible with TODO (Gardner Denver).

Each unit can be provided with 10 selectivity positions (see chart).

When ordering, please add "/SEL" and the chosen selectivity to the Mann Tek Code No.

Examples: S645B4401/**SEL 12**

With 10 Positions

12	13	14	15	23
24	25	34	35	45

1. Type of Coupling

A = API Adapter	H = Sampling Vent & Drain Unit	P = Dust Plug
AV = Tank Unit EN 13081 (special version)	I = Dust Plug ISO 45	R = Pressure Cap
B = Ball Valve	K = Dust Cap ISO 45	RG = Pressure Cap LPG
C = Dust Cap	L = Tank Unit LPG	S = Hose Unit (STANAG 3756)
CG = Dust Cap LPG	LC = Tank Unit Cryogenic	SN = Hose Unit int. Break Away Pin
D = Swivel	M = Hose Unit LPG	SO = Hose Unit int. Break Away Wire
E = Tank Unit with pressure valves	MC = Hose Unit Cryogenic	T = Tank Unit (STANAG 3756)
F = Hose Unit (ISO 45)	N = Break Away Pin	U = Filter / Sight Glass
G = Tank Unit (ISO 45)	NC = Break Away Pin Cryogenic	V = Dust Plug LPG
GS = Tank Unit (ISO 45) with selectivity	O = Break Away Wire	WA = Hose Fittings

2. Socket Diameter / Nominal Diameter

0 = 50 mm or 3/4"	4 = 119 mm or 3"	8 = 272 mm or 8"
1 = 56 mm or 1", 1 1/4"	5 = 164 mm or 4"	10 = 10"
2 = 70 mm or 1 1/2", 2"	V = 5"	12 = 12"
3 = 105 mm or 2 1/2"	6 = 238 mm or 6"	

3. Connection (Thread, Flange etc.)

01 = 3/4" BSP (female)	74 = 1 1/4" NPT (male)	146 = 5" Victaulic
02 = 3/4" NPT (female)	75 = 1 1/2" BSP (male)	147 = 2" BSPT (female)
03 = 1" BSP (female)	76 = 1 1/2" NPT (male)	148 = 2" BSPT (male)
04 = 1" NPT (female)	77 = 1 3/4" BSP (male)	149 = 1 1/2" Victaulic
05 = 1 1/4" BSP (female)	78 = 2" BSP (male)	150 = 2 1/2" Victaulic
06 = 1 1/4" NPT (female)	79 = 2" NPT (male)	151 = Flange 1" DIN 11864-2
07 = 1 1/2" BSP (female)	80 = 2 1/2" BSP (male)	152 = Flange 2" DIN 11864-2
08 = 1 1/2" NPT (female)	81 = 2 1/2" NPT (male)	153 = Flange Ø 135, 8 x M6
09 = 1 3/4" BSP (female)	82 = 3" BSP (male)	154 = 4" BSPT (female)
10 = 2" BSP (female)	83 = 3" NPT (male)	155 = 4" BSPT (male)
11 = 2" NPT (female)	84 = 4" BSP (male)	156 = Weld flange 2" Ø 61,5 ID
12 = 2 1/2" BSP (female)	85 = 4" NPT (male)	157 = 3" BSPT (female)
13 = 2 1/2" NPT (female)	86 = Weld.flange 2" Ø 60,5 ID	158 = Weld end 1 1/2" Ø 48 OD
14 = 3" BSP (female)	87 = Flange TW 1 (2" DN 50)	159 = Thread TR 57 x 4
15 = 3" NPT (female)	88 = Weld.flange 2" Ø 50 - Ø 70 (flat)	160 = Flange 2" BS10 Table D
16 = 4" BSP (female)	89 = Weld.flange 2" Ø 57 (int. chamfer)	161 = Flange 12" ANSI Class 150
17 = 4" NPT (female)	90 = Weld.flange 2" Ø 60 (outer chamfer)	162 = Flange 10" ANSI Class 150
18 = Flange undrilled Ø 156	91 = Weld.flange 3" Ø 75 - Ø 90 (flat)	163 = Flange DN 250 PN 16
19 = Flange undrilled Ø 165	92 = Weld.flange 3" Ø 76 (int. chamfer)	164 = M130 x 6 (female)
20 = Flange undrilled Ø 210	93 = Weld.flange 3" Ø 89 (outer chamfer)	165 = Flange 10" ANSI Class 300
21 = Flange undrilled Ø 230	94 = Weld.flange 4" Ø 100 - Ø 120 (flat)	166 = ACME 1 1/4" (female)
22 = Flange undrilled Ø 254	95 = Weld.flange 4" Ø 102 (int. chamfer)	167 = ACME 1 3/4" (female)
23 = Flange DN 25 PN 10/16	96 = Weld.flange 4" Ø 108 (int. chamfer)	168 = ACME 2 1/4" (female)
24 = Flange DN 25 PN 25/40	97 = Weld.flange 4" Ø 114 (outer chamfer)	169 = ACME 3 1/4" (female)
25 = Flange DN 32 PN 10/16	98 = Flange TW 1 (2" - DN 50)	170 = ACME 1 1/4" (male)
26 = Flange DN 32 PN 25/40	with drain connection	171 = ACME 1 3/4" (male)
27 = Flange DN 40 PN 10/16	99 = Flange DN 150 PN 25	172 = ACME 2 1/4" (male)
28 = Flange DN 40 PN 25/40	100 = Flange 6" ANSI Class 150	173 = ACME 3 1/4" (male)
29 = Flange DN 50 PN 25/40*	101 = Flange 6" ANSI Class 300	174 = Weld.flange Ø 76 (outer chamfer)
30 = Flange DN 50 PN 10/16	102 = Flange DN 200 PN 10	175 = Flange DN 15 PN 10/16
31 = Flange DN 50 PN 25/40	103 = Flange DN 200 PN 16	176 = Flange DN 15 PN 25/40
32 = Flange DN 65 PN 25/40*	104 = Flange DN 200 PN 25	177 = M130 x 6 (male)
33 = Flange DN 65 PN 10/16	105 = Flange 8" ANSI Class 150	178 = Flange 6" T.T.M.A.
34 = Flange DN 65 PN 25/40	106 = Flange 8" ANSI Class 300	179 = Flange DN 80 PN 25/40***
35 = Flange DN 80 PN 25/40*	107 = Flange Square ISO 45	180 = 1/2" NPT (male)
36 = Flange DN 80 PN 10/16	108 = S60 x 6 (female)	181 = 1/2" BSP (male)
37 = Flange DN 80 PN 25/40	109 = S60 x 6 (male)	182 = 5" BSP (female)
38 = Flange DN 100 PN 25/40*	110 = 6" BSP (female)	183 = 5" BSP (male)
39 = Flange DN 100 PN 10/16	111 = 6" NPT (female)	184 = Weld end 8" Ø 219 OD
40 = Flange DN 100 PN 25/40	112 = W2" - 7 (female)	185 = Weld end 6" Ø 168 OD
41 = Flange DN 125 PN 6	113 = Weld.flange 3" Ø 92 inner	186 = Flange DN 250 PN 25
42 = Flange DN 125 PN 10/16	114 = Square flange, 4 holes	187 = Flange 2" T.T.M.A.
43 = Flange DN 125 PN 25/40	115 = 6" BSP (male)	188 = Flange 3" BS10 Table D
44 = Flange DN 150 PN 6	116 = 6" NPT (male)	189 = Flange 1/2" ANSI Class 150
45 = Flange DN 150 PN 10/16	117 = 8" NPT (female)	190 = Flange 1" ANSI Class 150 Flat Face
46 = Flange DN 150 PN 25/40	118 = 4" Victaulic	191 = Flange 12" ANSI Class 300
47 = Flange DN 20 PN 10/16	119 = Flange DN 50 PN 25/40**	192 = Flange DN 250 PN 10
48 = Flange DN 20 PN 25/40	120 = Flange DN 65 PN 25/40**	193 = Weld end Ø 114 Schedule 40
49 = Flange 3/4" ANSI Class 150	121 = Flange DN 80 PN 25/40**	194 = Weld end Ø 114 Schedule 80
50 = Flange 3/4" ANSI Class 300	122 = Flange DN 100 PN 25/40**	195 = 6" Victaulic
51 = Flange 1" ANSI Class 150	123 = W2" - 7 (male)	196 = 1" Victaulic
52 = Flange 1" ANSI Class 300	124 = 5" NPT (female)	197 = DN 125 JIS 5K
53 = Flange 1 1/4" ANSI Class 150	125 = 5" NPT (male)	198 = DN 100 JIS 5K
54 = Flange 1 1/4" ANSI Class 300	126 = Flange DN 100 PN 6	199 = DN 80 JIS 5K
55 = Flange 1 1/2" ANSI Class 150	127 = Flange DN 80 PN 6	200 = DN 50 JIS 5K
56 = Flange 1 1/2" ANSI Class 300	128 = Flange DN 65 PN 6	201 = DN 40 JIS 5K
57 = Flange 2" ANSI Class 150	129 = Flange DN 50 PN 6	202 = Flange 2" DIN 11864-3
58 = Flange 2" ANSI Class 300	130 = Flange 8" ANSI Class 600	203 = 3 1/2" BSP (female)
59 = Flange 2 1/2" ANSI Class 150	131 = W90 x 1 1/8" (female)	204 = Flange Ø 110, Ø 86/Ø 5.5 (6x)
60 = Flange 2 1/2" ANSI Class 300	132 = 1/2" NPT (female)	205 = Weld end Ø 60 Schedule 80
61 = Flange 3" ANSI Class 150	133 = 1/2" BSP (female)	206 = Weld end Ø 89 Schedule 40
62 = Flange 3" ANSI Class 300	134 = Flange Ø 184.2, 6 holes	207 = Weld end Ø 89 Schedule 80
63 = Flange 4" ANSI Class 150	135 = Flange TW 7 (6" - DN 150)	208 = Flange DN 25 PN 6
64 = Flange 4" ANSI Class 300	136 = 4" ASSPT (female)	209 = Flange DN 32 PN 6
65 = Flange TW 1 (3" - DN 80)	137 = Triclamp DN 25	210 = Flange DN 40 PN 6
66 = Flange TW 3 (4" - DN 100)	138 = M54 x 1.5 (female)	211 = DN 125 JIS 10K
67 = Flange 3" T.T.M.A.	139 = Triclamp DN 50	212 = DN 100 JIS 10K
68 = Flange 4" T.T.M.A.	140 = Weld.flange Ø 73 (outer chamfer)	213 = DN 80 JIS 10K
69 = 3/4" BSP (male)	141 = 3" Victaulic	214 = DN 50 JIS 10K
70 = 3/4" NPT (male)	142 = Flange 5" ANSI Class 150	215 = DN 40 JIS 10K
71 = 1" BSP (male)	143 = 3" Ball valve	216 = Flange DN 80, holes Ø 14 (6x)
72 = 1" NPT (male)	144 = 2" Victaulic	217 = Flanges 5" ANSI Class 300
73 = 1 1/4" BSP (male)	145 = 3" BSPT (male)	

* EN 1092-1:2001 Type E: Spigot

** EN 1092-1:2001 Type F

*** EN 1092-1:2001 Type C

No part of this leaflet may be reproduced in any form or by any means without permission in writing from the publisher.

© Mann Teknik 2012
NOTE: When swivels are chosen (first sign: D), the second and the third sign indicate thread side 1 one, the fourth and the fifth sign the second outlet indicate thread side 2.
Design may change without notice.

4. Version

- | | | |
|---------------------------------------|---|------------------------------|
| A = Version No. 1 (machined from bar) | G = Drain connection | P = Pressure (Custom) |
| B = Version No. 2 (casted) | H = Leaf spring lock | S = Sight Glass |
| C = Version No. 3 (kokill casted) | I = Bent (dropped) Tank Unit, short (15°) | T = Transparent |
| D = Sep. piston guide | J = Bent (dropped) Tank Unit (15°) | U = Stop before disconnected |
| E = Injection moulded | K = Short Tank Unit/Swivel | |
| F = 6" Flange Hydrant | N = Non Return Valve | |

5. Material Coupling and Body

- | | |
|--------------------------------|---------------|
| 1 = Aluminium | 6 = Titan |
| 2 = Brass | 7 = Hastelloy |
| 3 = Steel | 8 = PVDF |
| 4 = Edeltahl 1.4408 (AISI 316) | 9 = PEEK |
| 5 = Edeltahl 1.4301 (AISI 304) | |

6. Material in the Innerparts

- | | | |
|------------------------------|-------------|---------------|
| 1 = Aluminium | K = Inconel | 6 = Titan |
| 2 = Brass | | 7 = Hastelloy |
| 3 = Steel | | 8 = PVDF |
| 4 = Stainless steel A4 (316) | | 9 = PEEK |
| 5 = Stainless steel 1.4301 | | K = Inconel |

7. O-Rings

- | | | |
|------------------------------------|--|---|
| 01 = Viton® (FPM/FKM) | 16 = Hypalon® (CSM) | 34 = Kalrez® 0040 |
| 02 = Nitrile (NBR) | 17 = Chemraz® 505 (FFKM) | 37 = Chemraz® 510 (90 Shore) |
| 03 = EPDM | 18 = Xyflour® 860 (AFKM) | 40 = FEP or PTFE encapsulated Viton® |
| 04 = Kalrez® (FFKM) 6375 | 19 = Zetpol® / Therban® (HNBR) | 50 = Kalrez® (PFPM) 1050LF |
| 05 = NBR Low temp | 20 = NBR 90° shore | 51 = Nylon® (PA) |
| 06 = Teflon® (PTFE) | 21 = Viton® GF (Special Viton quality) | 61 = Viton® (FPM), FDA, USP C6 & ADI |
| 07 = Neoprene® (CR) | 22 = Composite | 62 = Nitrile (NBR), FDA, USP C6 & ADI |
| 08 = Silicone (Q) | 23 = Viton® GFLT-S | 63 = EPDM, FDA, USP C6 & ADI |
| 09 = Polyurethane (PUR) | 24 = Viton® GLT | 64 = Kalrez® (FFKM) 6230, FDA, USP C6 & ADI |
| 10 = Butyl (IIR) | 25 = Klingerit® | 66 = PTFE (Virgin), FDA |
| 11 = Nitrile (Gasol NBR 70 K-6) | 26 = POM | 71 = FPM/FKM Low Temp |
| 12 = Perfluorelastomer (FFPM/FFKM) | 27 = Epichlorhydrin (ECO) | 77 = Chemraz® SD517, FDA, USP C6 & ADI |
| 13 = PVC/NBR | 28 = Viton® GFLT-S NMO | 83 = EPDM, BAM certified for oxygene |
| 14 = Fluorsilicone rubber (MFQ) | 31 = Viton® 90 Shore (FPM/FKM) | |
| 15 = FEP encapsulated silicone | 33 = EPDM 291 | |

8. Flat (Thread) Seals / Extras

- | | | |
|---------------------------------------|--|--------------------------------------|
| A = Flat Seal, Teflon® (PTFE) | M = Two-Step Cam Curve | U20 = Pressure Bleeding valve 20 bar |
| B = Flat Seal, Vulkollan® (PUR) | N = No Branding | V = Locked Hose Unit |
| C = 2-Way Ball Valve | NA = Ball Valve w. square trunnion (no actuator) | W = Swivel with double ball valve |
| D = Flat Seal, Viton® (FPM) | P = Pressure Equalizing Valve | X = Special surface treatment |
| DA = Double Acting (Ball Valve) | Q = Sampling Vent & Drain Unit with reduced bore diameter (Argus, Hydrant) | Z = Excentric Tank Unit |
| E = Tank Unit with short piston | R = Hose Unit with int. Break Away | -RA = Racing |
| F = Flange thickness acc. to standard | S = Sampling Vent & Drain Unit, only with one ball valve | -LC = Locking Cap |
| G = Flat Seal, Hypalon® | SR = Spring Return (Ball Valve) | -S = FEP O-Ring in Hose Unit swivel |
| H = Flat Seal, Nitrile (NBR) | T = TW-Flange extended circles | -ST = Steam |
| I = Emco compatible | U = Pressure Bleeding Valve 16 bar | -XL = Oversized swivel |
| J = Flat Seal, EPDM | U5 = Pressure Bleeding Valve 5 bar | -45 = 45 Mesh |
| K = Adapter with locked piston guide | | -60 = 60 Mesh |
| L = Locked thread (maggot screw) | | -10 = 100 Mesh |

ID-Tag on Coupling:



Example:

2" (Ø 70 mm) Hose Unit (Coupler), female thread

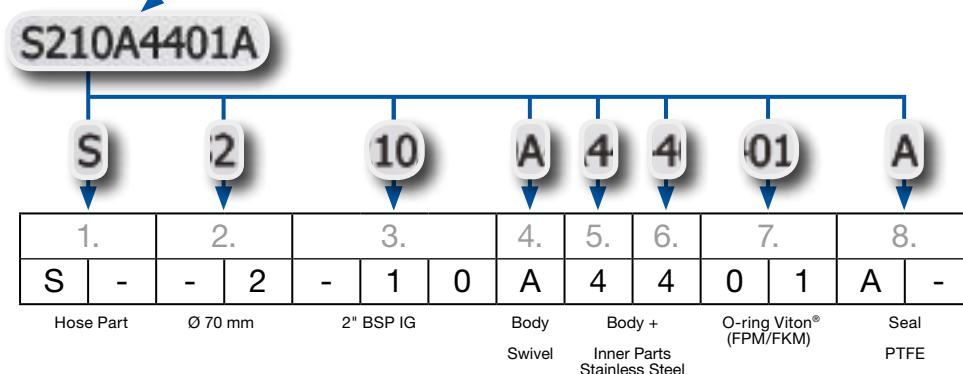

No part of this leaflet may be reproduced in any form or by any means without permission in writing from the publisher.

Design may change without notice.

Couplings with Special Flanges

On request we manufacture all combinations of flange thickness / holes and length

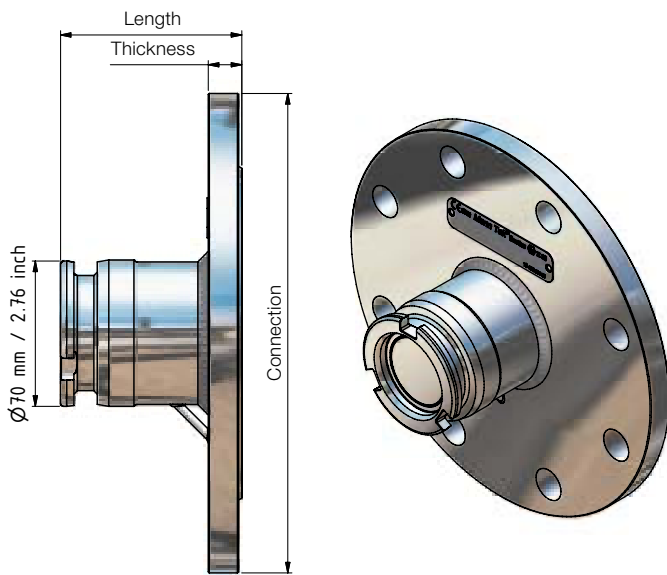

Example: 2" (Ø 70 mm) tank unit (adapter) with flange 4" ANSI 150 psi, Code No: T263A4401

Tank Unit with Short Piston



When coupled, the piston spindle does not protrude. This special type is useful e.g. for the direct connection to ball valves.

Example Mann Tek Code No.: T230B1101E

Tank Unit with Drain Connection

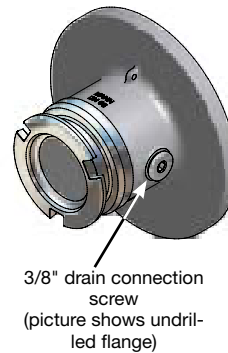

Für easy venting and sampling.

Available for all tank units with flange.

Example Mann Tek Code No.: T298G1101 (f. TW1 Flansch)

Tank Unit (Adapter) – Eccentric Flange

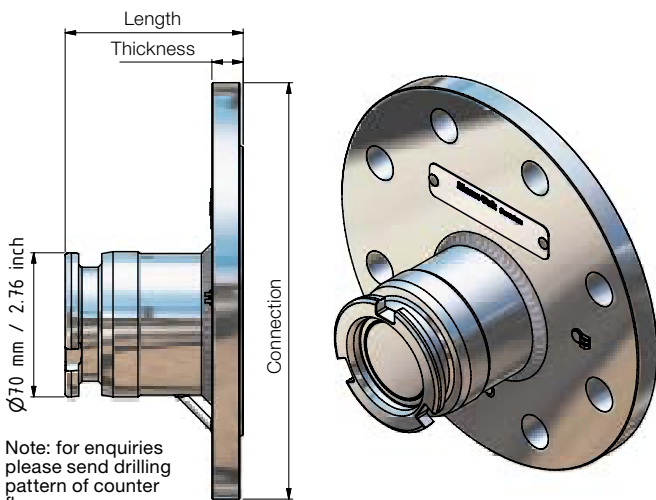

Tank unit (adapter) with eccentric flange, available in sizes from 1" to 6".

Example 2" (Ø 70 mm) tank unit with eccentric flange 4" ASA 150, Mann Tek Code-Nr.: T263A4401Z

Traditional Flange

Liquid left in the tube

Tank unit with traditional flange

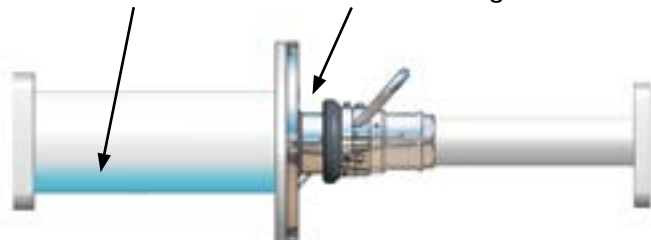

Eccentric Flange

No Liquid left in the tube

Tank unit with eccentric flange

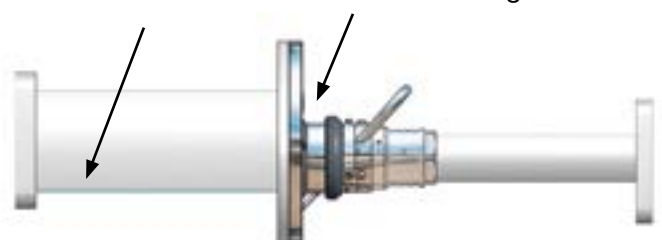

Tank Unit / Hose Unit with flange EN 1092-1 Type E (Spigot) / Type F (Recess)

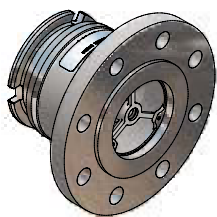

Tank Unit
Flange EN 1092-1
Type E (Spigot)

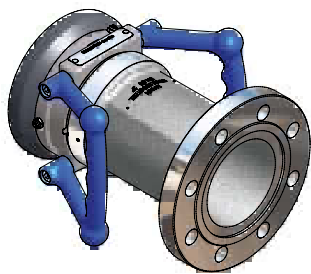

Hose Unit
Flange EN 1092-1
Type F (Recess)

Standard flange connections are usually executed with sealing surface Type A (Flat Face) oder Type B (Raised Face), see page 44.

Current alternatives are Type E (Spigot) and Type F (Recess), which are used from some road and rail tank manufacturers.

With Victaulic® Connection

All DDCouplings can be manufactured with grooved pipe ends, compatible with the Victaulic system.

Suitable e.g. for military and offshore applications.

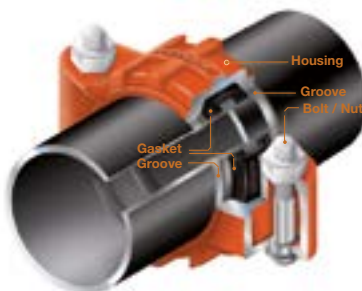

Victaulic® is a registered brand name of Victaulic Europe

Example Mann Tek Code-Nr. **S2144A1101**

Hose Unit with Locking Device to Avoid Unwanted Disconnection

After the coupling the connection is automatically locked and can not loosen unintentionally. Pulling ring version LD-S2 or lever version L-S5, available for hose units (couplers) of any size.

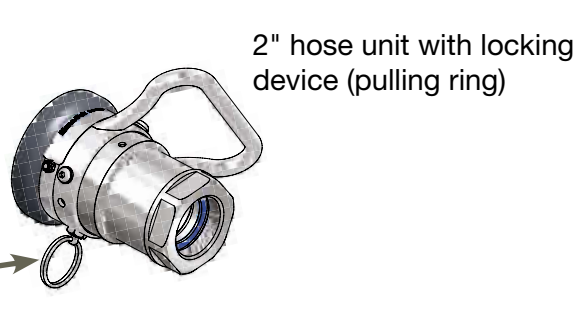
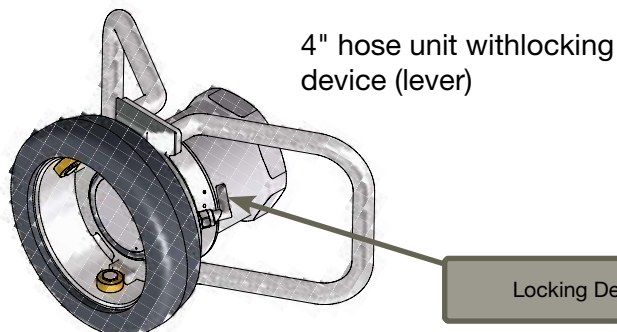

Example: Addition to Mann Tek Code-Nr. ... **L-S5**

Example: Addition to Mann Tek Code-Nr. ... **LD-S2**

Hose Unit with Ground Cable Assembly

Ground cables serve for the safe electrostatic dissipation of electrical currents (potential equalization).

They are prescribed for some applications, e.g. for aircraft refuelling.

Materials: Cable stainless with plastic coating, crocodile clamp brass, including assembly.

Mann Tek Code No. **G-F3-12-XXX**.

When ordering please substitute **XX** with the required length (mm).



Hose Unit with Integrated SBC Break Away



Where there is a risk of excessive force on the hose due to unexpected movement between the loading and unloading station.

For these application DDCouplings with integrated SBCouplings (Safety Break Away) are available.

Please add 'N' to the Mann Tek Code No., Example: **SN211A4401**.

Hose Unit with Non-Return Valve

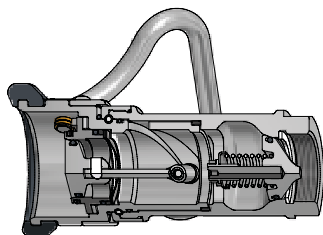

The medium can not flow back when the pump switches off while the coupling is still connected. Suitable for some wet hose applications.

Example Mann Tek Code-Nr.: **S210N1101B**

Hose Unit for Old Emco Version

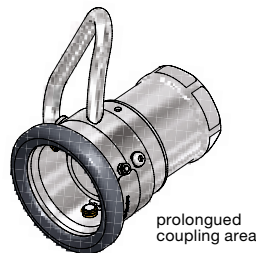

2" (Ø 70 mm) coupler in 'big mouth' special version, compatible with older Emco Wheaton tank units

Example Mann Tek Code No.: **S210A1101BI**

Hose Unit f. Emergency Unloading

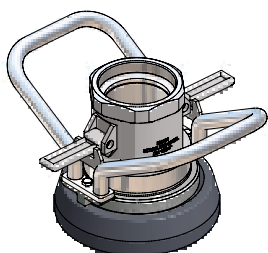

For the emergency unloading of rail or road tankers, the swivel of the coupler must be blocked for a fast connection with standard thread connections without tools.

Several different versions are available from Mann Tek.

Extended Handles



Extended handle for 2", 2½" and 3" Hose unit

Hose Unit with Electronic Sensor



Induktive Sensor
to DC-PNP or
NAMUR Standard



Electronic Sensor

The sensor is detecting the position of the driving plate inside the hose unit.

No modification on the tank unit is needed. That makes it possible to identify if the hose unit is connected to a tank unit and if they are in an open position.

Available with ATEX on request **Ex II 2G**

Z : Option Sensor	S2 : for 2" coupling
S1 : for 1" coupling	S4 : for 3" coupling
S3 : for 2½" coupling	S6 : for 6" coupling
S5 : for 4" coupling	
44 : Housing material Stainless Steel	
A1 : DC-PNP	A2 : NAMUR Standard

Example: additional Mann Tek Code No.
... + **Z-S1-44-A1**

Hose or Tank Unit with Pressure Bleeding Valve

Only for special operating conditions where there is the risk of excessive pressure increase through warming in the pipe / hose system.

To protect the equipment, the optional pressure bleeding valve opens at a predetermined pressure limit.

Other applications: adapter pieces between different DDCouplings, hose assemblies with DDCouplings or DACouplings on both sides, e. g. military applications (logistic supply lines).

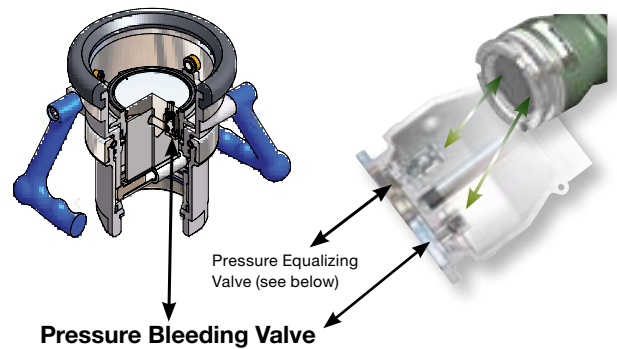

Pressure Bleeding Valve

Example Mann Tek Code No. S210A1101BU

Tank Units with Pressure Equalizing Valve

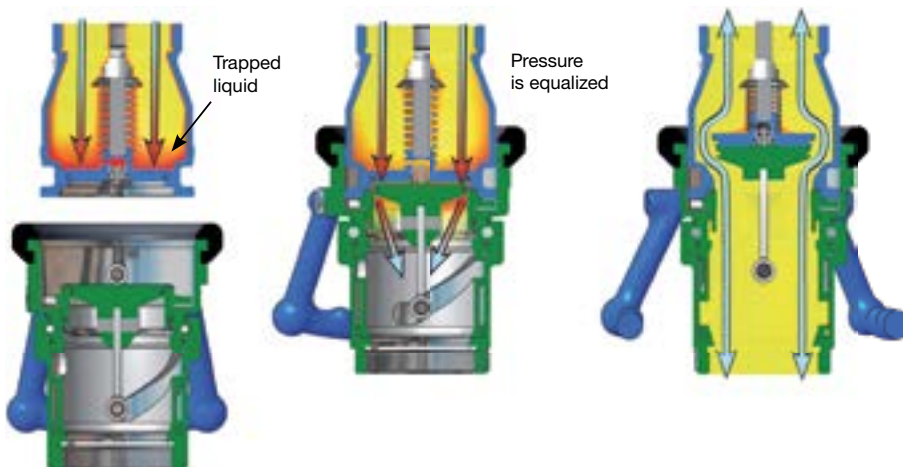

If liquid can get trapped in the tank unit during operation so that it can not escape, there is the risk that the tank unit is damaged during coupling.

Process engineering solution: open valves behind the tank unit to relieve the trapped liquid.

Technical solution: the optional pressure equalizing valve relieves the pressure during coupling into the hose unit.

Trapped liquid in tank unit (above)

Pressure equalizing valve opens during the coupling

Open – pressure is equalized, full flow

Example Mann Tek Code No. S210A1101BP

Sight Glass with Integrated Strainer

for Petroleum Based Products

Tank and hose units in size 2½" BSP/NPT or 3" BSP/NPT are available with an additional sight glass with integrated strainer. During operation it is easy to see when the strainer shall be cleaned.



– easy service of the strainer due to quick connection –



45 mesh

Plastic



60 mesh

Stainless Steel



100 mesh

Stainless Steel

Three different screen sizes are available, 45 mesh (350 µm), 60 mesh (250 µm) or 100 mesh (150 µm).

Example for Code No. 'Sight Glass with Strainer: U1280S1101-XX – when ordering, replace XX with -45 for 45 mesh, -60 for 60 mesh, -10 for 100 mesh.

Colour Coding

For a clear assignment of coupling and medium, the body, flange and handles of our couplings are available in any required colour.



Couplings with Aseptic Flange

DDCouplings are available with aseptic flanges to DIN 11864-2 or Triclamp flange connection.

Applications: for foodstuffs/beverages, fine chemicals, filter and water treatment plants.

Note: not suitable for pharmaceutical media with highest requirements to sterility.

On request for the mentioned coupling a test according GMP can be effected.

Tank and Hose Units with Aseptic Flange to DIN 11864-2
FDA conform seals

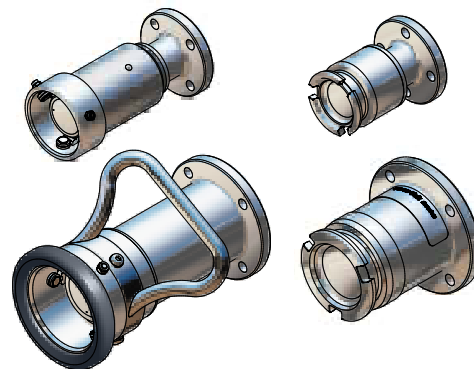

Tank and Hose Units with Triclamp Connection to DIN 32676
FDA conform seals

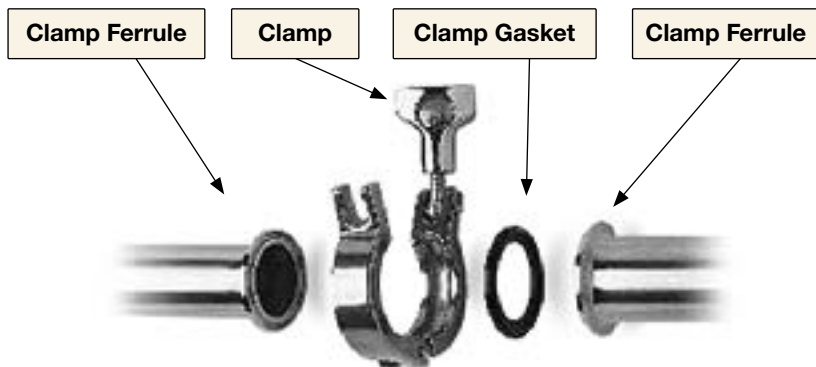
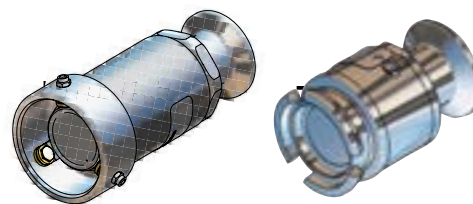

Tools for the Installation / Dismounting

DDCouplings can be installed and dismantled without special tools, with standard wrenches.

Additionally, below mentioned tools are helpful to open the piston (the valve plates) to empty the system:



Wrench size to install or dismount tank and hose units:



Tool for draining tank units



Tool for draining hose units

for Coupling	Wrench Size
1"	SW 50 mm
2"	SW 65 mm
2½"	SW 85 mm
3"	SW 100 mm
4"	Tank Unit - 125 mm Hose Unit - 130 mm
6"	SW 190 mm

Flange Facing Types to EN 1092

Type A
Flat Face



Type B
Raised Face

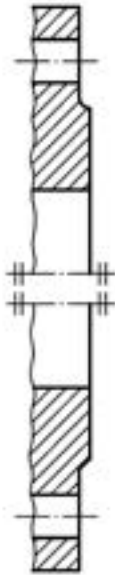

Type C
Tongue



Type D
Groove



Type E
Spigot



Type F
Recess



Type G
O-Ring Spigot



Type H
O-Ring Groove



Flange Measurements – 1/2

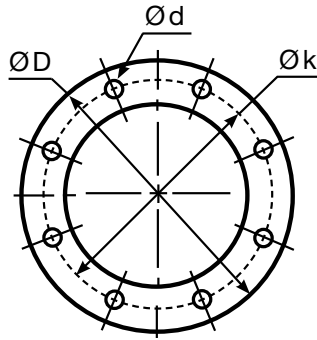

ØD = Diameter
 Øk = Centre Diameter
 n = Number of Holes
 Ød = Hole Diameter

EN 1092-1																	
DN		PN 10				PN 16				PN 25				PN 40			
		ØD	Øk	n	Ød	ØD	Øk	n	Ød	ØD	Øk	n	Ød	ØD	Øk	n	Ød
20	mm	105	75	4	14	105	75	4	14	105	75	4	14	105	75	4	14
	inch	4.13	2.95		0.55	4.13	2.95		0.55	4.13	2.95		0.55	4.13	2.95		0.55
25	mm	115	85	4	14	115	85	4	14	115	85	4	14	115	85	4	14
	inch	4.53	3.35		0.55	4.53	3.35		0.55	4.53	3.35		0.55	4.53	3.35		0.55
32	mm	140	100	4	18	140	100	4	18	140	100	4	18	140	100	4	18
	inch	5.51	3.94		0.71	5.51	3.94		0.71	5.51	3.94		0.71	5.51	3.94		0.71
40	mm	150	110	4	18	150	110	4	18	150	110	4	18	150	110	4	18
	inch	5.91	4.33		0.71	5.91	4.33		0.71	5.91	4.33		0.71	5.91	4.33		0.71
50	mm	165	125	4	18	165	125	4	18	165	125	4	18	165	125	4	18
	inch	6.50	4.92		0.71	6.50	4.92		0.71	6.50	4.92		0.71	6.50	4.92		0.71
65	mm	185	145	4	18	185	145	4	18	185	145	8	18	185	145	8	18
	inch	7.28	5.71		0.71	7.28	5.71		0.71	7.28	5.71		0.71	7.28	5.71		0.71
80	mm	200	160	8	18	200	160	8	18	200	160	8	18	200	160	8	18
	inch	7.87	6.30		0.71	7.87	6.30		0.71	7.87	6.30		0.71	7.87	6.30		0.71
100	mm	220	180	8	18	220	180	8	18	235	190	8	22	235	190	8	22
	inch	8.66	7.09		0.71	8.66	7.09		0.71	9.25	7.48		0.87	9.25	7.48		0.87
125	mm	250	210	8	18	250	210	8	18	270	220	8	26	270	220	8	26
	inch	9.84	8.27		0.71	9.84	8.27		0.71	10.63	8.66		1.02	10.63	8.66		1.02
150	mm	285	240	8	22	285	240	8	22	300	250	8	26	300	250	8	26
	inch	11.22	9.45		0.87	11.22	9.45		0.87	11.81	9.84		1.02	11.81	9.84		1.02
200	mm	340	295	8	22	340	295	12	22	360	310	12	26	375	320	12	30
	inch	13.39	11.61		0.87	13.39	11.61		0.87	14.17	12.20		1.02	14.76	12.60		1.18
250	mm	395	355	12	22	405	355	12	26	425	370	12	30	450	385	12	33
	inch	15.55	13.98		0.87	15.94	13.98		1.02	16.73	14.57		1.18	17.72	15.16		1.30
300	mm	445	400	12	22	460	410	12	26	485	430	16	30	515	450	16	33
	inch	17.52	15.75		0.87	18.11	16.14		1.02	19.09	16.93		1.18	20.28	17.65		1.30

Flange Translation EN 1092 / DIN (old)

EN 1092-1	DIN (old)
EN 1092-1 PN 6	DIN 2631
EN 1092-1 PN 10	DIN 2632
EN 1092-1 PN 16	DIN 2633
EN 1092-1 PN 25	DIN 2634
EN 1092-1 PN 40	DIN 2635
EN 1092-1 Type B (Raised Face)	DIN 2526 Form C
EN 1092-1 Type C (Tongue)	DIN 2512 Form F
EN 1092-1 Type D (Groove)	DIN 2512 Form N
EN 1092-1 Type E (Spigot)	DIN 2513 Form V
EN 1092-1 Type F (Recess)	DIN 2513 Form R

Flange Measurements – 2/2

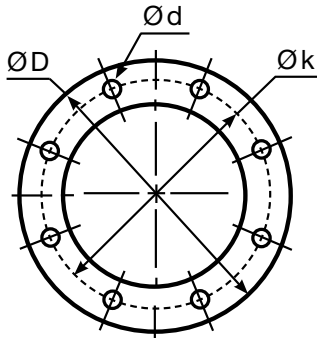

$\varnothing D$ = Diameter
 $\varnothing k$ = Centre Diameter
 n = Number of Holes
 $\varnothing d$ = Hole Diameter

ANSI (ASA) B 16,5									
Inch		150 psi				300 psi			
		$\varnothing D$	$\varnothing k$	n	$\varnothing d$	$\varnothing D$	$\varnothing k$	n	$\varnothing d$
3/4"	mm	98,4	69,8	4	15,9	117,5	82,5	4	19
	inch	3 7/8	2 3/4		5/8	4 5/8	3 1/4		3/4
1"	mm	107,7	79,4	4	15,9	123,8	88,9	4	19
	inch	4 1/4	3 1/8		5/8	4 7/8	3 1/2		3/4
1 3/4"	mm	117,5	88,9	4	15,9	133,3	98,4	4	19
	inch	4 5/8	3 1/2		5/8	5 1/4	3 3/8		3/4
1 1/2"	mm	127	98,4	4	15,9	155,6	114,3	4	22,2
	inch	5	3 7/8		5/8	6 1/8	4 1/2		7/8
2"	mm	152,4	120,6	4	19	165,1	127	8	19
	inch	6	4 3/4		3/4	6 1/2	5		3/4
2 1/2"	mm	177,8	139,7	4	19	190,5	149,2	8	22,2
	inch	7	5 1/2		3/4	7 1/2	5 3/8		7/8
3"	mm	190,5	152,4	4	19	209,5	168,3	8	22,2
	inch	7 1/2	6		3/4	8 1/4	6 3/8		7/8
4"	mm	228,5	190,5	8	19	254	200	8	22,2
	inch	9	7 1/2		3/4	10	7 7/8		7/8
5"	mm	254	215,9	8	22,2	279,4	234,9	8	22,2
	inch	10	8 1/2		7/8	11	9 1/4		7/8
6"	mm	279,4	241,3	8	22,2	317,5	269,9	12	22,2
	inch	11	9 1/2		7/8	12 1/2	10 5/8		7/8
8"	mm	342,9	298,4	8	22,2	381	330,2	12	25,4
	inch	13 1/2	11 3/4		7/8	15	13		1
10"	mm	406,4	361,9	12	25,4	444,5	387,3	16	28,6
	inch	16	14 1/4		1	17 1/2	15 1/4		1 1/8
12"	mm	482,6	431,8	12	25,4	520,7	450,8	16	31,7
	inch	19	17		1	20 1/2	17 3/4		1 1/4

DIN 28459						
	DN	$\varnothing D$	$\varnothing k$	n	$\varnothing d$	
TW 1	50	mm	154	130	8	11
		inch	6.06	5.12		0.43
TW 1	80	mm	154	130	8	11
		inch	6.06	5.12		0.43
TW 3	100	mm	174	150	8	14
		inch	6.85	5.91		0.55
TW 5	125	mm	204	176	8	14
		inch	8.03	6.93		0.55
TW 7	150	mm	240	210	12	14
		inch	9.45	8.27		0.55

T.T.M.A					
Inch	$\varnothing D$	$\varnothing k$	n	$\varnothing d$	
2"	mm	114,3	95,3	6	11,1
	inch	4.50	3.75		0.44
3"	mm	142,9	123,8	8	11,1
	inch	5.63	4.87		0.44
4"	mm	168,3	149,2	8	11,1
	inch	6.63	5.87		0.44
5"	mm	196,9	177,8	8	11,1
	inch	7.75	7.00		0.44
6"	mm	228,6	206,4	12	11,1
	inch	9.00	8.13		0.44
8"	mm	276,2	257,2	16	11,1
	inch	10.87	10.13		0.44

Thread Seals (Flat Seals)

Weight ≈ kg	Thread BSP	Materials / Application	Dimensions ≈ mm			Mann Tek Code No.
			D	d	s	
0,001	BSP ½"	PTFE (Teflon®) white, massive continuously hard, universally resistant Teflon® is a registered trademark of DuPont	20	13	2	On request
0,001	BSP ¾"		26	19	2	1498-06
0,002	BSP 1"		33	24	2	1220-06
0,003	BSP 1¼"		42	34	2	1536-06
0,003	BSP 1½"		48	39	2	1196-06
0,004	BSP 2"		60	49	2	1052-06
0,007	BSP 2½"		76	63	2,5	1181-06
0,006	BSP 3"		88	77	3	1110-06
0,009	BSP 4"		114	100	3	1295-06
0,016	BSP 6"		164	150	3	1963-06
0,001	BSP ½"	Thermopac asbestos free, light, hard. Especially for hot oils and hot bitumen up to 250° C and for hot water and saturated steam up to 25 bar.	20	13	2	On request
0,001	BSP ¾"		26	19	2	1498-25
0,002	BSP 1"		33	24	2	1220-25
0,002	BSP 1¼"		42	34	2	1536-25
0,003	BSP 1½"		48	39	2	1196-25
0,004	BSP 2"		60	49	2	1052-25
0,005	BSP 2½"		76	63	3	1181-25
0,009	BSP 3"		88	77	3	1110-25
0,013	BSP 4"		114	100	3	1295-25
0,016	BSP 6"		164	150	3	1963-25
0,001	BSP ½"	FPM/FKM (Viton®) soft for aromatic hydrocarbons and hot oils. Viton® is a registered trademark of DuPont.	20	13	2	On request
0,001	BSP ¾"		26	19	2	1498-01
0,002	BSP 1"		33	24	2	1220-01
0,002	BSP 1¼"		42	34	2	1536-01
0,003	BSP 1½"		48	39	2	1196-01
0,004	BSP 2"		60	49	2	1052-01
0,006	BSP 2½"		76	63	3	1181-01
0,008	BSP 3"		88	77	3	1110-01
0,014	BSP 4"		114	100	3	1295-01
0,016	BSP 6"		164	150	3	1963-01
0,001	BSP ¾"	PUR (Polyurethane) Flat seals type of polyurethane, highly resistant to abrasion, non-toxic. Shore hardness = 90°. For all petroleum based products and many solvents. Colour: Blue	26	19	2	1498-09
0,001	BSP 1"		33	24	2	1220-09
0,001	BSP 1¼"		42	34	2	1536-09
0,002	BSP 1½"		48	39	2	1196-09
0,003	BSP 1¾"		54	44	2,5	On request
0,003	BSP 2"		60	49	2	1052-09
0,005	BSP 2½"		76	63	2,5	1181-09
0,006	BSP 3"		88	77	3	1110-09
0,010	BSP 3½"		100	80	3	On request
0,009	BSP 4"		114	100	3	1295-09
0,012	BSP 5" (No std.)	140	124	3	On request	
0,016	BSP 6"	164	150	3	1963-09	

PTFE (Teflon®)

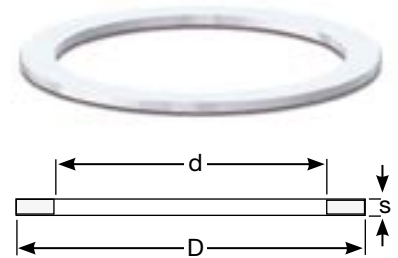

Thermopac

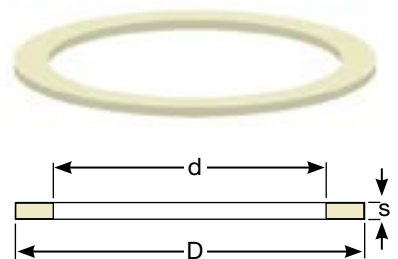

FPM/FKM (Viton®)

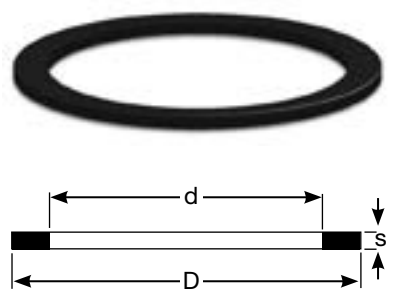

PUR (Polyurethane®)

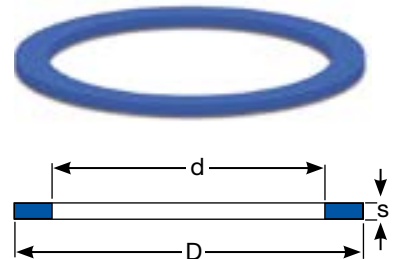

Viton® and Teflon® are registered trademarks of DuPont, DuPont Elastomers.

O-Ring Materials

Designation	Trade name	ISO 1629	ASTM 1418	Temp. Range °C		Field of Application
Nitrile Butadiene Rubber / Nitrile Rubber	Buna N® Europrene N® Hycar® Nipol N® Perbunan®	NBR	NBR	-55	110	Petroleum based products / aliphatic hydrocarbons (gasoline, diesel, oils, petroleum, propane, butane). Animal and vegetal oils and fats. Flame retardant liquids.. Silicone oils and greases. Water up to 80° C.
Ethylene-Propylene Diene Rubber	Dutral Keltan® Vistalon® Buna AP®	EPDM	EPDM	-55	120	Water, hot water, vapour, brake fluids, detergents. Alcohols, ketons, engine coolants, phosphate based flame retardants, organic and inorganic acids and alkalis. Not suitable for petroleum based products.
Fluoroelastomer	Fluorel® Technoflon® Viton®	FPM	FKM	-20	200	Petroleum based products / aliphatic hydrocarbons (gasoline, diesel, oils, petroleum, propane, butane) - also with high additive content. Phosphate based flame retardants. Silicone oils and greases, acids and alkalis.
Fluorosilicone Elastomer	—	MFQ	FVMQ	-60	200	Additional to the properties of silicone elastomers, fluorosilicone elastomers show a considerably higher resistance to oils, fuels and solvents - especially to aromatic and aromatic and chlorinated hydrocarbons and alcohols.
Silicone	Silastic® Silopren®	MVQ	VMQ	-60	200	Very good heat and cold resistance, very good resistance to oxygene, ozone, UV rays and wheather influence. High electrical insulating properties, physiologically safe.
Hydrogenated Nitrile Butadiene Rubber	Therban® Tornac® Zetpol®	HNBR	HNBR	-35	120	Very good resistance to petroleum based products / aliphatic hydrocarbons like NBR, but better resistance to high temperature, ageing and wheather influence. Excellent physical properties also with high temperatures.
Butyl Rubber	Exxon Butyl® Polysar Butyl®	IIR	IIR	-55	100	For O-Rings this material has largely been replaced by EPDM. Butyl is resistant to the same fluid types as EPDM and -except for resistance to gas permeation- it is somewhat inferior to EPDM for O-Ring use. Excellent weather resistance and gas permeation resistance. Not suitable for petroleum based products.
Perfluorinated Elastomer	CHEMRAZ® Kalrez® PERLAST®	FFPM	FFPM	-40	260	Best chemical resistance of all elastomers, including organic acids, acetic acid, benzoic acid, formic acid.
Chloroprene Rubber	Baypren® Neoprene®	CR	CR	-40	120	Resistant to refrigerants, ammonia, carbon dioxide, freon (R12, R13, R21, R22, R113 - R115), silicone oils, water, oxygen (low pressure), alkalis, coustic soda, alcohols, chlorine, ozone, castor oil and vegetable oils. Properties of CR are similar to NBR but slightly lower resistance to petroleum based products, better resistance to ageing, UV light and ozone.
Polyester / Polyether Urethane Rubber	Polyurethane Adiprene® Urepan® Desmopan®	PU PUR AU EU	AU EU	-40	100	Very good resistance to petroleum based products, also with aromatic content. Good resistance to ozone and ageing. Very good mechanical properties. Not resistant to esters, concentrated acids and lyes, water above +50° C.
Polytetrafluoroethylene	Teflon®	PTFE	PTFE	-200	260	Universal chemical resistance except liquid alkaline metals and some fluorine compounds. Very good anti friction properties, low wear. High temperature resistance. Physiologically safe. Use for statical seals only.
Fluorinated Ethylene Propylene	Teflon FEP®	FEP/MVQ	FEP/VMQ	-60	200	Universal chemical resistance except liquid alkaline metals and some fluorine compounds.
		FEP/FPM	FEP/FKM	-20	200	Very good anti friction properties, low wear. High temperature resistance. Physiologically safe.
Perflouralkoxy	Teflon PFA®	PFA/MVQ	PFA/VMQ	-60	250	Universal chemical resistance except liquid alkaline metals and some fluorine compounds.
		PFA/FPM	PFA/FKM	-20	250	Very good anti friction properties, low wear. High temperature resistance. Physiologically safe.
Tetrafluoroethylene-Propylene Copolymer Elastomer	Aflas®	—	TFE / P	-25	200	Petroleum based products, oils and greases, brake fluids, fuels, alcohols, heat transfer media, oils. amines, acids, alkalis.

Note: Specifications in this chart are based on the information given by our suppliers together with published guides. This is not always a guarantee for a proper function. If in doubt, please ask our sales team, stating medium and operating conditions.

Comparison NPT and BSP Threads

NPT (Conical Thread)

Please observe the following basic rules :

1. Always use some type of sealant (tape or paste) and apply sealant to male thread only. If using a hydraulic sealant, allow sufficient curing time before system is pressurized.
2. When using tape sealant, wrap the threads in a clockwise motion, starting at the first thread (open end of the coupling) and following the thread direction.
3. When using paste sealant, apply to threads with a brush, using the brush to work the sealant into the threads. Apply enough sealant to fill in all the threads all the way around.
4. When connecting two parts of the same material that will require future disassembly, use a special sealant paste to avoid seizure (galling) of the thread.
5. When connecting parts made of different metals (e. g. steel and aluminium), standard tape or paste sealant is sufficient.
6. For sizes 2" and below, tape and paste perform satisfactory. When using thread tape, four wraps (covering all necessary threads) are usually sufficient.
7. For sizes 2½" and above, thread paste is recommended. If thread tape is used, eight wraps (covering all necessary threads) are usually sufficient. Apply more wraps if necessary.
8. For stubborn-to-seal threads, apply a normal coating of thread paste followed by a normal layer of thread tape.

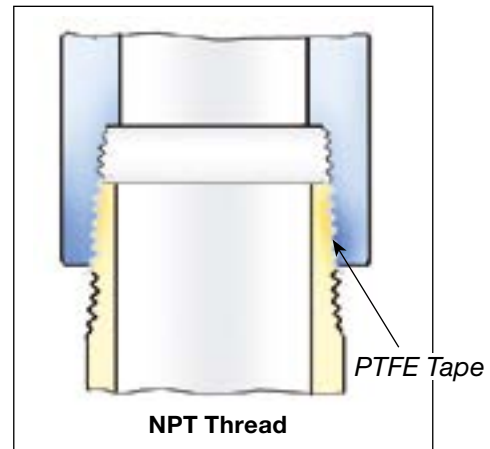

9. For extremely stubborn to seal threads, apply a normal coating of thread paste followed by a single layer of gauze bandage followed by a normal layer of thread tape.

Note: When this procedure is done, the connection becomes permanent. Extreme measures will be necessary to disconnect these components. All other measures to seal the threads should be explored prior to use of this technique.

10. Over-tightening threads can be just as detrimental as insufficient tightening.

Couplings with conical (tapered) female and male threads normally have no flat sealing surface. The screwed-on thread jams before the end of the counter thread is covered. Therefore a sealing with a thread seal is not possible. The overall length of such a connection is always longer than the equivalent flat sealing system. A safe and promptly tight connection requires expert knowledge and clean work and is time-consuming. Subsequent tightening during operation is not possible. A new assembly requires the proper cleaning of the pitch from all squashed and hardened remains of the sealing compounds.

For these reasons, BSP parallel threads should be preferred.

BSP (Parallel Thread)

Easy sealing with flat thread seals :

Standard hose fittings are supplied with parallel threads and a flat sealing surface. This allows to use the full thread length for screwed-on parts. Due to the short length, a good transfer of force is guaranteed.

The thread seal is positioned within a recess of the female part and can not fall out. For a safe connection, the parts simply have to be screwed together – subsequent tightening during operation is possible at any time. A change of seals or reassembly do not require any expert knowledge. The European standardisations for hose assemblies require parallel threads with flat seals, because of these advantages.

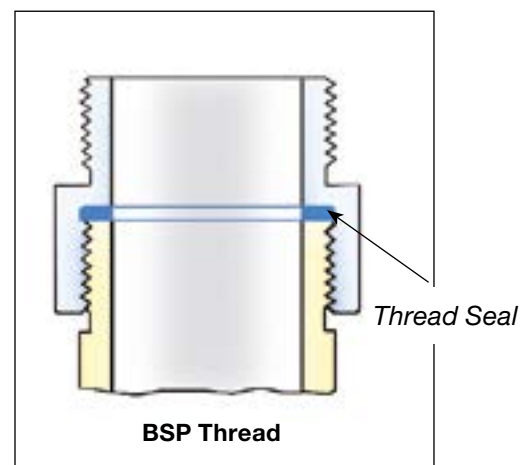

Operating Advice for Mann Tek Couplings

This advice is supplementary to your standard terminal operational procedures.

DACouplings, DDCouplings and DGCouplings are specifically designed for the bulk transfer of liquids and vapours. The materials of construction, including the seals should already be confirmed as compatible prior to installation. If in doubt, check before operation. Our help documents "Installation advice for DACouplings, DDCouplings and DGCouplings" plus "Specification Advice" are designed to assist you.

All DACouplings, DDCouplings and DGCouplings are marked with a maximum pressure rating that shall not to be exceeded. With careful use and regular maintenance they will give safe and trouble free operating for many years.

Service instructions are available for all DACouplings, DDCouplings and DGCouplings upon request. The life expectancy and maintenance frequency of the couplings is dependent upon many variables such as cycles/day, pressures, contaminants etc., but the most significant factor besides correct installation is the correct use. The following information is designed to assist in your care of the couplings and associated equipment.

Daily visual inspection

All hose units should be briefly inspected at the start of each day's operation. Look inside the connection socket. Check that the three rollers are not obviously damaged. Check that the connection socket area is free from dirt and foreign objects.

Check for signs of seal damage (eg. you may see a cut seal or small pieces of rubber coming from the piston area).

Check that the swivel of the hose unit rotates freely. For the first use, check for leakage and smooth coupling operation.

Each tank unit on the truck should also be briefly checked prior to use. Check for dirt, tightness and any obvious physical damage.

Connecting & disconnecting

a) Hose unit: When making the connection make sure that all relevant isolation valves connected to the hose unit are closed. Also check that no pumping pressure is present at the hose unit.

b) Tank unit: Make sure that all isolation valves behind the tank unit in the pipe work are fully open.

c) Lift the hose unit and hose into position to start the connection. Take care to support the hose end assembly so as to present the hose unit to the tank unit in the correct orientation. It is important to ensure that the hose unit is not supporting the full weight of the hose assembly during the connection process. Once connected, the hose unit will accommodate all reasonable strain of a balanced loading arm or hose assembly. The handles have no operating purpose other than providing handling assistance during the connection phase.

d) When correctly supported, the hose unit should slide easily over the tank unit. The three rollers engage in the three slots in any one of three positions at 120 degree centre. To allow the hose unit to locate to the tank unit, and still supporting the hose assembly, rotate the hose unit whilst gently pushing towards the tank unit.

e) Still supporting the hose assembly, rotate the hose unit clockwise about 100 degrees. At the start of rotation you will feel some resistance. The level of resistance is dependent upon the static line and tank pressure. The higher the pressure, the greater the effort necessary to connect the coupling.

At the completion of the 100 degree turn you will feel a definite stop. Do not attempt to rotate the unit further. Further rotation does not tighten the connection or open the valves more, it only cause unnecessary damage. Hose and tank unit valves are now open and the loading process can start.

f) The sequence of isolation valve and pump operation should be taken from your operating procedures. Preferably,

the isolation valve on the tank unit side should be opened *first*, because trapped liquid in the tank unit could make it impossible to couple. The isolation valve on the hose unit side is usually opened *after* coupling.

g) Disconnect the coupling in reverse order. First, all isolation valves should be closed and - where possible - the pumps be switched off. Where a common pumping system is in use, all flow through the coupling shall be stopped using the isolation valves and not by the coupling. Closing the isolation valve on the hose unit side first is preferred because of the reasons stated in section (f), as long as this is compatible with your standard operating procedures.

h) Whilst supporting the hose unit assembly, turn the hose unit anti-clockwise approximately 100 degrees. You may feel a slight "pop off" effect at the end of the rotation travel when transferring liquids with an elevated vapour pressure. This is normal. Do not attempt to rotate the hose unit further. This will not further loosen the connection or secure the seal, it only causes unnecessary damage.

i) While supporting the hose assembly, pull the hose unit away from the tank unit. You may feel a small resistance due to seal vacuum. Correctly supported, the hose unit will come away from the tank unit with ease.

j) The hose assembly should be stowed in a manner so as to avoid physical damage. Do not drop the hose end assembly or stow on the floor. The dust plug provided should always be fitted.

k) Ensure the tank unit dust cap (if fitted) is coupled and secured.

l) Do not use anything other than the handles provided to operate the coupling. The handles are specifically designed to provide sufficient assistance in operation. Should the couplings become difficult to operate, they should be inspected prior to further use. Under no circumstances should the couplings be subjected to excessive force. The use of damaged or faulty equipment may have serious safety consequences.

Service Instructions for DDCouplings

We recommend the use of dust plugs/caps.

Daily inspection:

1. Inspect the coupling surface for cleanliness and corrosion
2. Inspect the O-ring in the hose unit connection for serviceability and correct seating in the groove
3. Inspect the hose unit swivel for free rotation
4. Inspect tank and hose unit for faultlessness and external signs of leakage
5. Inspect the hose unit rollers for easy rotation and for external signs of seizure

Instructions for Correct Installation and Maintenance of Mann Tek Couplings

All DACouplings, DDCouplings and DGCouplings are designed for trouble free operation in a wide range of applications and operating conditions.

Reliable and safe operation is dependent upon the correct installation and handling of the equipment.

Regular and appropriate maintenance is essential to ensure both safety and reliability over the life of the equipment.

Specifications

Before you install Mann Tek couplings, it is essential to check that the material and performance specifications are acceptable for your specific application. The pressure ratings and primary materials of the construction are clearly indicated on the identification tag of each Mann Tek product. A drawing showing the materials of construction relating to each individual component is available upon request. If required, the technical department at Mann Tek will provide

guidance on material suitability. Our data is taken from published chemical resistance information as well as our own application experiences.

Specification checks should always be carried out before the product is supplied, but if unsure, please ask. Especially if you are using the couplings outside the standard temperature range (-20°C to +80°C), ask for confirmation regarding your application.

Do not assume that a Mann Tek coupling supplied for one specific application automatically will be suitable for other similar applications.

Many variables affect the performance of materials. If you wish to use a DACoupling, DDCoupling or DGCoupling for a different application than the one originally specified, check with Mann Tek to ensure compatibility before installation. Please remember, the application details should include all media transferred through the

coupling, not just the primary transferred media.

As with all equipment, a check should be made to ensure that the installation fulfils the requirements of applicable prevailing industry, local, national and international standards.

Particular attention should be paid to pressure ratings, safety factors and the position of upstream and downstream affiliated closures.

Installation

The correct installation of Mann Tek Couplings is essential to ensure safe and satisfactory operation. Checks should be made to ensure that their installation does not interfere with the correct operation of affiliated equipment (i.e. isolation valve, excess flow valves, etc).

continued on next page

Instructions for Correct Installation and Maintenance of Mann Tek Couplings

Before securing the flange or thread connection to the mating equipment (i.e. hose, loading arm, storage tank) ensure that no dirt or foreign objects are present in the coupling. All flange and thread connections should be made without excessive strain to the equipment. Prior to use they should be pressure checked at least to 1.5 times of the maximum application working pressure. All gaskets and sealing materials used to make the permanent connection should be of suitable material and able to operate at least up to the maximum parameters of the Mann Tek coupling.

When installing DACouplings, DDCouplings and DGCouplings to new pipe work, tanks etc. ensure the system is free from debris that may be transferred through the coupling.

Where the hose or loading arm assembly is the primary static dissipation or earth route, the electrical continuity value of the assembly shall be checked to ensure regulatory compliance.

Special attention should be paid to the balancing of loading arms. The weight of the coupling plus transfer media should be taken into account at the specification stage. It is usual for loading arm balance settings to account of weight variations due to differences in the full/empty cycle. The loading arm should be set to balance in the condition present at the time of connection. For example, should the loading arm be empty at the time of connection then it should be balanced in the empty condition.

Each DACoupling, DDCoupling and DGCoupling is designed to take reasonable loads associated with good handling practice but is not designed to accept continuous excessive loads associated with maladjustment or poor installation. Continuous excessive strain will lead to increased component wear and, if no actions will be taken, damaging the coupling and adjacent units up to failure of the connection. This means, under circumstances, high follow-up costs for environmental and personal injuries.

When Mann Tek couplings are used with hoses, attention should be paid to hose length to ensure correct handling characteristics. The hose assembly should be designed such that the hose weight is supported by the coupling or the operator. Hoses should have a sufficient length to ensure operation well within the stipulated hose minimum bending radius. It is recommended to apply Safety Break-Away Couplings to protect the whole loading equipment against unintended external forces, e.g. caused by a drive-away accident. Further, measures against electrostatic loads are needed, especially at higher flow velocities (above approx. 5 m/s for fuels).

Prior to putting the system in use, a function check should be carried out. The hose unit (coupler) should connect and disconnect without physical interference or difficulty. Please note – the higher the static pressure, the greater the effort to make a connection. For more details please read the 'Operating Advice for Mann Tek Couplings'.

Maintenance

All DACouplings, DDCouplings and DGCouplings should be visually checked for damage, etc. on a daily or shift basis according to the handling instructions. Any sign of damage or operating difficulty should be reported and acted upon at the earliest opportunity. Do not continue to use any equipment that is not operating satisfactorily as continued use will cause further deterioration and possible equipment failure.

Mann Tek couplings are designed such that all normal wear parts are included in appropriate maintenance kits. For normal applications, where the material is not, or only marginally attacked by the medium, the coupling will be fully usable after the regular maintenance.

We recommend that the coupling is fully inspected, tested and serviced at least once a year. It must be accepted that some applications cause a greater level of component degradation either by

chemical attack or by arduous physical or environmental conditions. In such circumstances a more frequent regime of inspection and service may be required. We recommend that in such applications a three monthly inspection should be carried out with automatic replacement of the hose unit piston and carrier seals. All other service parts and key components should also be checked. In addition to the three monthly inspection and primary seal replacement, the hose unit shall have the full repair kit applied every year independent from component condition. After a representative period of time it may be possible to increase the service / inspection interval, but only against a background of satisfactory operation.

Full service instructions complete with photographs are available for each DACoupling, DDCoupling and DGCoupling size. These instructions show the service method as well as tools required and parts identification. DACouplings, DDCouplings and DGCouplings are easy to maintain.

Some Mann Tek distributors are trained and accredited by Mann Tek to carry out service of Mann Tek couplings. Alternatively, Mann Tek offers a maintenance and repair service in their workshop. A service training can be offered as well, either on or off site to customers engineers who wish to carry out servicing themselves.

Mann Tek equipment should only be serviced by trained personnel.

The distributor of Mann Tek couplings has full responsibility to enclose this information to the customer. If the customer does not understand English the Distributor also have the responsibility to translate this document to a language the customer fully understand.

Flow Diagram (Pressure Drop Curve) for DDC

Test method to STANAG 3756, Annex E

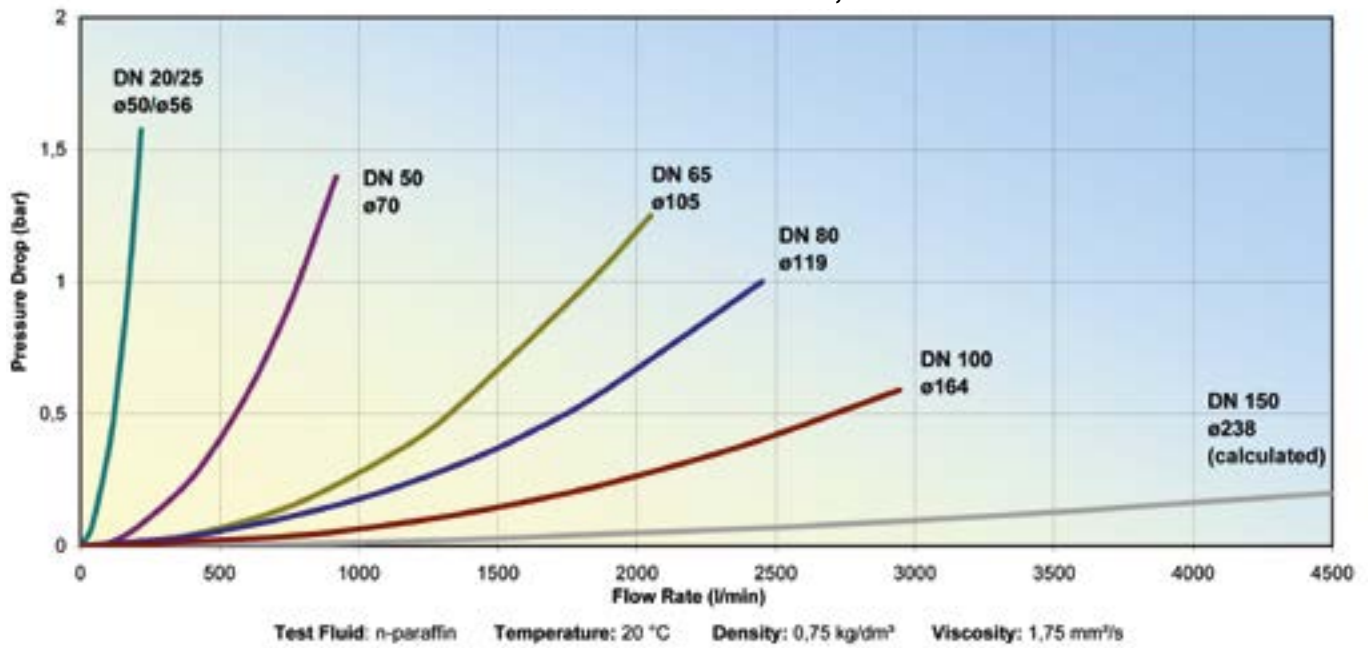

Pressure Drop Measurement

Test method to STANAG 3756, Annex E

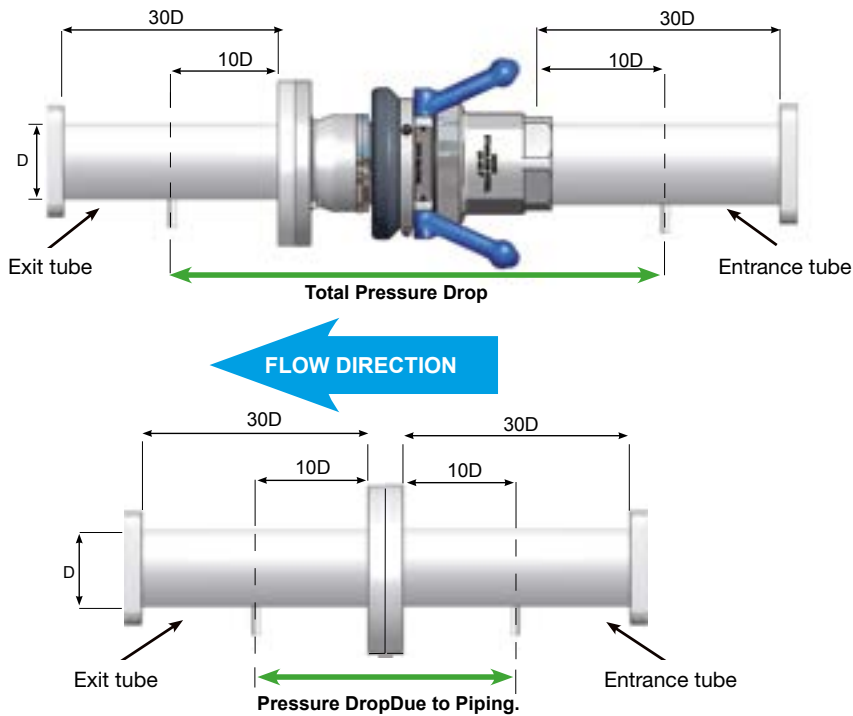

Pressure Drop DDCoupling = ΔP

Pressure Drop Mann Tek DDCoupling = Total Pressure Drop - Pressure Drop Due to Piping

Repair service and Certificate of Decontamination



Repair Service

To comply with Health & Safety Regulations, all returned couplings and valves must be accompanied by a Certificate of Cleanliness and a data sheet for the last product carried (also for the cleaning medium).

Certificate of Decontamination

We certify that the returned couplings/valves have been cleaned prior to despatch and are free of any harmful substances.

Quantity: _____

Code No.: _____

Serial No.: _____

Quantity: _____

Code No.: _____

Serial No.: _____

Quantity: _____

Code No.: _____

Serial No.: _____

Quantity: _____

Code No.: _____

Serial No.: _____

YES NO

Free of all liquid _____

Air blown _____

Coupling/Valve dismantled _____

The last known product the coupling/valve was in contact with:

EU/CAS/UN Number:

Data sheet of last YES NO

Product attached _____

Company

Name/Address

Signature of Supervisor:

Company Stamp:

When sending used couplings or valves to Mann Tek, please fill in this form and enclose it to the attach to the shipment.

Mann Teknik AB
Strandvägen 16, S-542 31 Mariestad / Sweden
Tel. +46 (0)501 - 39 32 00
Fax +46 (0)501 - 39 32 00
www.mann-tek.com · E-Mail: sales@mann-tek.se



Product Information



DDCouplings®

Dry Disconnect Couplings

1" to 8", PN 16 – PN 25.

Aluminium, brass/gunmetal, stainless steel and PEEK. Other materials on request.

According to NATO standard STANAG 3756.



DGCouplings®

Dry Gas Couplings

1" to 4", PN 25.

Stainless steel. Other materials on request.



DACouplings®

Dry Aviation Couplings

2½", PN 10, aluminium

According to ISO 45, MS 24484, NATO STANAG 3105, British Aerospace Spec. 2C14



Sampling, Vent or Drain Unit

Stainless steel



FFBall Valves

Full Flow Ball Valves

2" to 4", PN 10, aluminium

1- and 2-way Ball Valves for petroleum tank trucks.



Swivel Joints

¾" to 10", PN 10-PN 25.

Aluminium, brass/gunmetal, stainless steel. Other materials on request.

Connection: BSP, NPT. Flanged connection (DIN, ANSI / ASA, etc.)



SBCouplings

Safety Breakaway Couplings

Industrial and Marine Version with Breaking Bolts

1" to 12", PN10/25, aluminium, brass, stainless steel

Cable Release Version

2" to 12", PN10/25, stainless steel

Business Segment Information



Offshore & Marine



Gas (LPG)



Rail Tankers



Chemical Industry

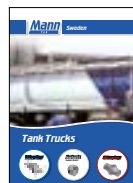

Tank Trucks

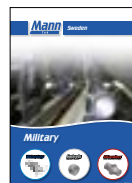

Military



Container

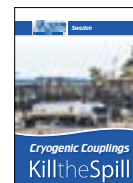

Cryogenic Couplings
KilltheSpill

Company Information

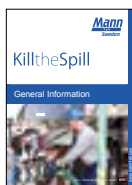

General information about Mann Tek, products and business segments.

Approval Information



Quality, health, safety and environment policy. Quality approvals, product approvals and declaration of conformity.

Service



Service instructions and operation manuals.

Contact

t hmGAASBEEK B.V.

's-Gravelandseweg 369

3125 BJ Schiedam

The Netherlands

Tel.: +31 (0) 10 - 462 39 11

e-mail: info@thmgaasbeek.nl

www.thmgaasbeek.nl

www.safety-coupling.com